

TSOL-DCU1000/P1000/B1000



Plug and play



Stackable up to  
5kWh battery



WiFi monitoring



Flexible for home or  
portable usage

FOR



**DC Coupled Unit**

Household electricity

**TSUNESS Co., Ltd**

sales@tsun-ess.com www.tsun-ess.com +86-512-66186028

# DC Coupled Unit

Fits right between PV panel and microinverter, offers storage option for existing balcony PV systems.

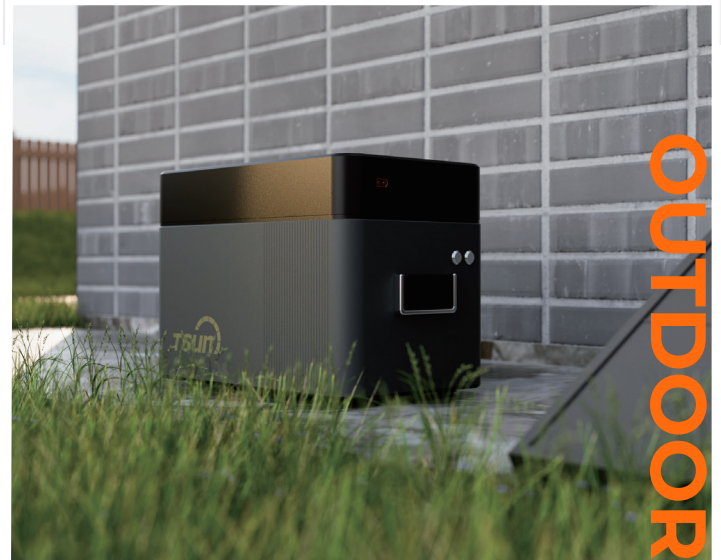

**DCU1000**

**DC Coupled Unit 1.024Kwh**  
Input 1200W DC Output 800W

**P1000**

**Portable Station Accessory**  
Input 600W AC Output 1000W

**B1000**

**Battery Pack 1.024kwh**

**B1000**

**Battery Pack 1.024kwh**

## Key Features



Maximize PV generation into local consumption



Not only for home storage, with optional accessories, it can transfer into portable battery bank for blackout or outdoor use



Plug and play design for DIY, no need for professional



WiFi monitoring, accessible via TSUN Smart app



Energy Saving and Environmental Protection

# 6 Unique Design

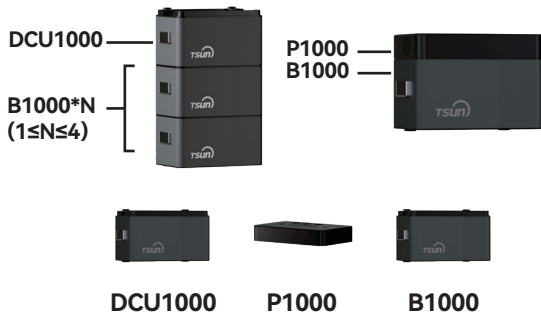

### Modular Stackable Design:

Flexible modular design allows the system to expand according to household needs, providing a convenient and quick solution.

**Indoors**  
Balcony Solar Storage System

**Outdoors**  
Portable Power Station

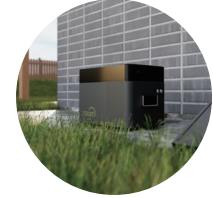

### Versatile Application Combinations:

Suitable for various scenarios, including home, outdoor, and emergency situations, meeting diverse electricity demands.

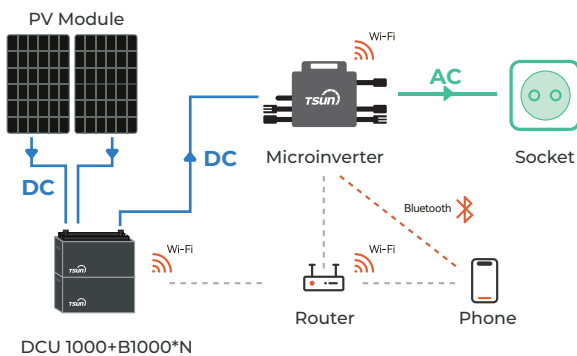

### Smart Control:

Integrates 2.4G WiFi wireless communication technology for intelligent control through a mobile app, enabling remote monitoring and operation. Module stacking allows for automatic networking, ensuring simplicity and ease of use.

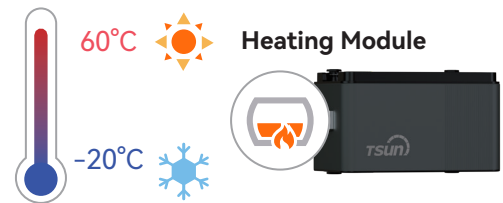

**Wide Temperature Range Adaptability:**  
Built-in battery heating module enables stable operation in extreme temperatures ranging from -20°C to 60°C.

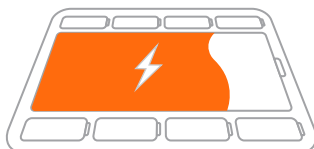

### Long-life Battery:

Utilizes safety power batteries, offering a long cycle life and high safety performance, ensuring stable system operation and user safety.



### IP65 Certification

It possesses an IP65 certification, allowing it to withstand diverse weather conditions and special circumstances.

## Indoors——Balcony Solar Storage Solution

The DCU1000 is a crucial component of the balcony solar storage system: The Smart Lithium Battery Pack, when combined with solar photovoltaic panels and microinverters, forms the balcony solar storage system. **One DCU1000 can connect four B1000.**

Designed with modularity in mind and can be paralleled with up to 5 units at most, helping households make the most of limited space, achieve energy self-sufficiency, and reduce electricity costs by 1/3.

### System Diagram——DCU 1000+B1000

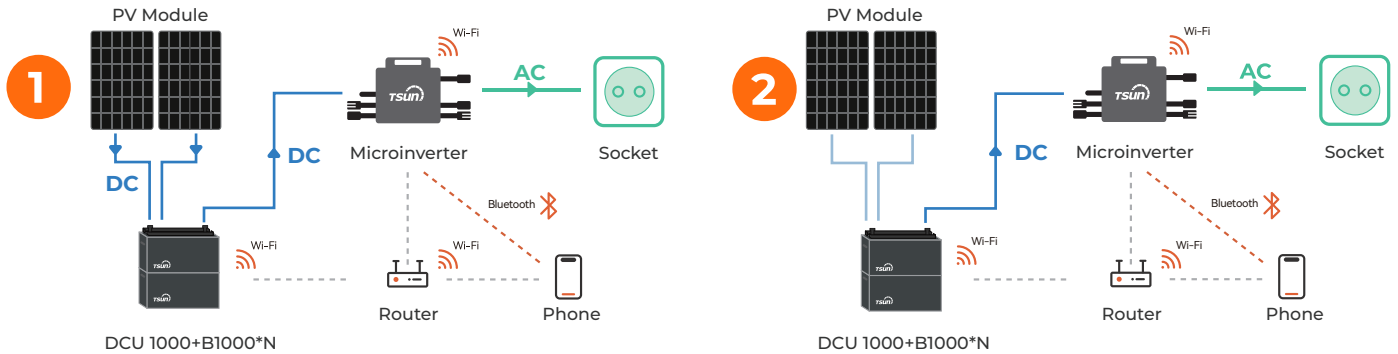

Sufficient photovoltaic power, charging

Insufficient photovoltaic power, discharge

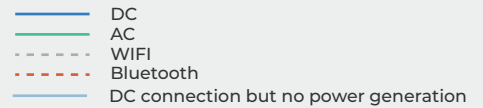

## Outdoors——Portable Power Station

B1000 Battery flexibly combine with P1000 inverter module to form a portable power station, making it the ideal companion for camping and other outdoor activities. **One P1000 can connect one B1000.**

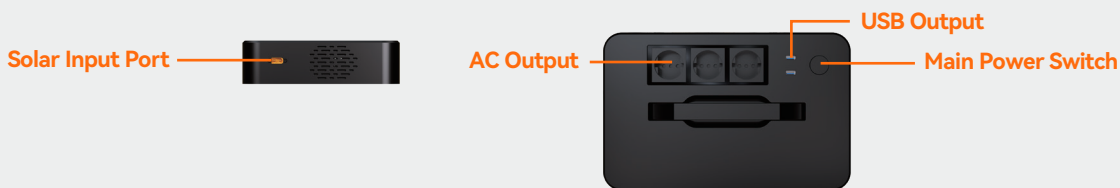

### System Diagram——P1000+B1000



Sufficient photovoltaic power, charging

Insufficient photovoltaic power, discharge

# Technical Data

Model	DCU1000
<b>Mainframe(Single Pack)</b>	
Capacity	1024 Wh
Size(L*W*H)	12.99*8.27*7.68(in)/ 330*210*195(mm)
Weight	24.25lbs/ 11kg
Battery Type	LiFePO4
Cycle Life	6000 Cycles, Remaining Capacity ≥ 70%
Input Voltage	18-55Vdc
Input Current Max	15A
Maximum Input Power	1200W
Maximum Output Power	800W
Output Voltage Range	20-50Vdc
Maximum System Capacity	5120Wh
Protection Level	IP65
Operating Temperature	-20°C-60°C (Smart Battery Heating Module)
<b>Protection</b>	
Overcharge	Support
Overdischarge	Support
Overcurrent	Support
High Temperature	Support
Low Temperature	Support
Short Circuit Protection	Support
<b>Others</b>	
WiFi Module	Support
Balancing Mode	Support

Model	P1000
<b>Split Type Inverter</b>	
Size(L*W*H)	12.99*8.27*2.36(in)/ 330*210*60(mm)
Weight	5.51lbs/ 2.5kg
Input Voltage	42-58VDC (Rated 48VDC)
Noise	≤55dB
AC Output Voltage	220V~240V
Rated Output Frequency	50Hz/60Hz
Max. PV Input Power	600W
AC Output Power	1000W
Protection Functions	Under Voltage Input Protection/ Output Short Circuit Protection/ Output Overload Protection/ High Temperature Protection/ Low Temperature Protection
Pallet	96 Units/ Pallet

Model	B1000
Battery Capacity	1024Wh
Product Dimensions	12.99*8.27*7.68(in)/ 330*210*195(mm)
Battery Type	LiFePO4
Rated Battery Voltage	48V
Voltage Range	40V~58.4V
Typical Max Current	50A
Under-voltage Alarm Point	47V±5%
Under-voltage Protection Point	40V±5%
Protection Function	63A
Battery Fuse	Short Circuit Protection, Overload Protection, Overcurrent Protection, Temperature Protection, Overvoltage and Under-voltage Protections
Reverse Polarity Protection	Open Circuit of the Internal Fuse
Operating Temperature	-20°C-60°C (Smart Battery Heating Module)
Operating Humidity	10%~90% Non-condensing
EMI Degree	CLASS B
Protection Degree	IP65
Pallet	54 Units/ Pallet

## **TSUNESS Headquarter**

E-mail: [sales@tsun-ess.com](mailto:sales@tsun-ess.com)

Tel: +86 512 6618 6028

Add: 2F, Building 2, No. 55 Aigehao Road, Xiangcheng District, Suzhou, China

Add: Building E1, No. 555, Chuangye Road, Dayun Town, Jiashan Country, Jiaxing City, Zhejiang Province, China

