

Quick Installation Guide - Easy Solar Kit

TSOL-ESK400-Air(A)

Read Me First

1. Two or more persons are required.
2. Proper tools and skills are required.
3. Wear work gloves during installation.
4. Prevent devices falling during installation.
5. No shadows on the PV panel.

1. Es sind zwei oder mehr Personen erforderlich.
2. Es sind geeignete Werkzeuge und Fähigkeiten erforderlich.
3. Tragen Sie während der Installation Arbeitshandschuhe.
4. Verhindern Sie, dass Geräte während der Installation herunterfallen.
5. Keine Schatten auf dem PV-Modul.

1. Duas ou mais pessoas são necessárias.
2. Ferramentas e habilidades adequadas são necessárias.
3. Use luvas de trabalho durante a instalação.
4. Evite que os dispositivos caiam durante a instalação.
5. Sem sombras no painel fotovoltaico.

1. Sono necessarie due o più persone.
2. Sono necessari strumenti e competenze adeguati.
3. Indossare guanti da lavoro durante l'installazione.
4. Prevenire la caduta dei dispositivi durante l'installazione.
5. Nessuna ombra sul pannello fotovoltaico.











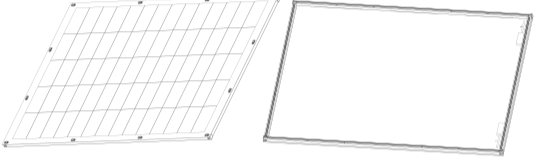

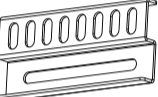
1. Er zijn twee of meer personen nodig.
2. De juiste tools en vaardigheden zijn vereist.
3. Draag werkhandschoenen tijdens de montage.
4. Voorkom dat apparaten vallen tijdens de installatie.
5. Geen schaduwen op het PV-paneel.

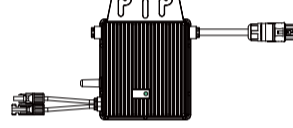
1. Deux personnes ou plus sont requises.
2. Des outils et des compétences appropriés sont nécessaires.
3. Portez des gants de travail pendant l'installation.
4. Empêcher les appareils de tomber pendant l'installation.
5. Aucune ombre sur le panneau PV.

1. Wymagane są dwie lub więcej osób.
2. Wymagane są odpowiednie narzędzia i umiejętności.
3. Podczas instalacji nosić rękawice robocze.
4. Zapobiegaj upadkowi urządzeń podczas instalacji.
5. Brak cieni na panelu fotowoltaicznym.

1. Se requieren dos o más personas.
2. Se requieren herramientas y habilidades adecuadas.
3. Use guantes de trabajo durante la instalación.
4. Evite que los dispositivos se caigan durante la instalación.
5. Sin sombras en el panel fotovoltaico.

Packing List

	Box1	Box2		Box1	Box2		Box1	Box2
M9 	0	2	S14 	1	0	S9 	1	4
			S17 	0	4	T1 	1	1
M8 	1	0	S16 	0	4	SN 	1	1
B6 	0	4	S15 	2	0	Quick Installation Guide 	0	1
S11 	1	8	S18 	0	12			

Installation

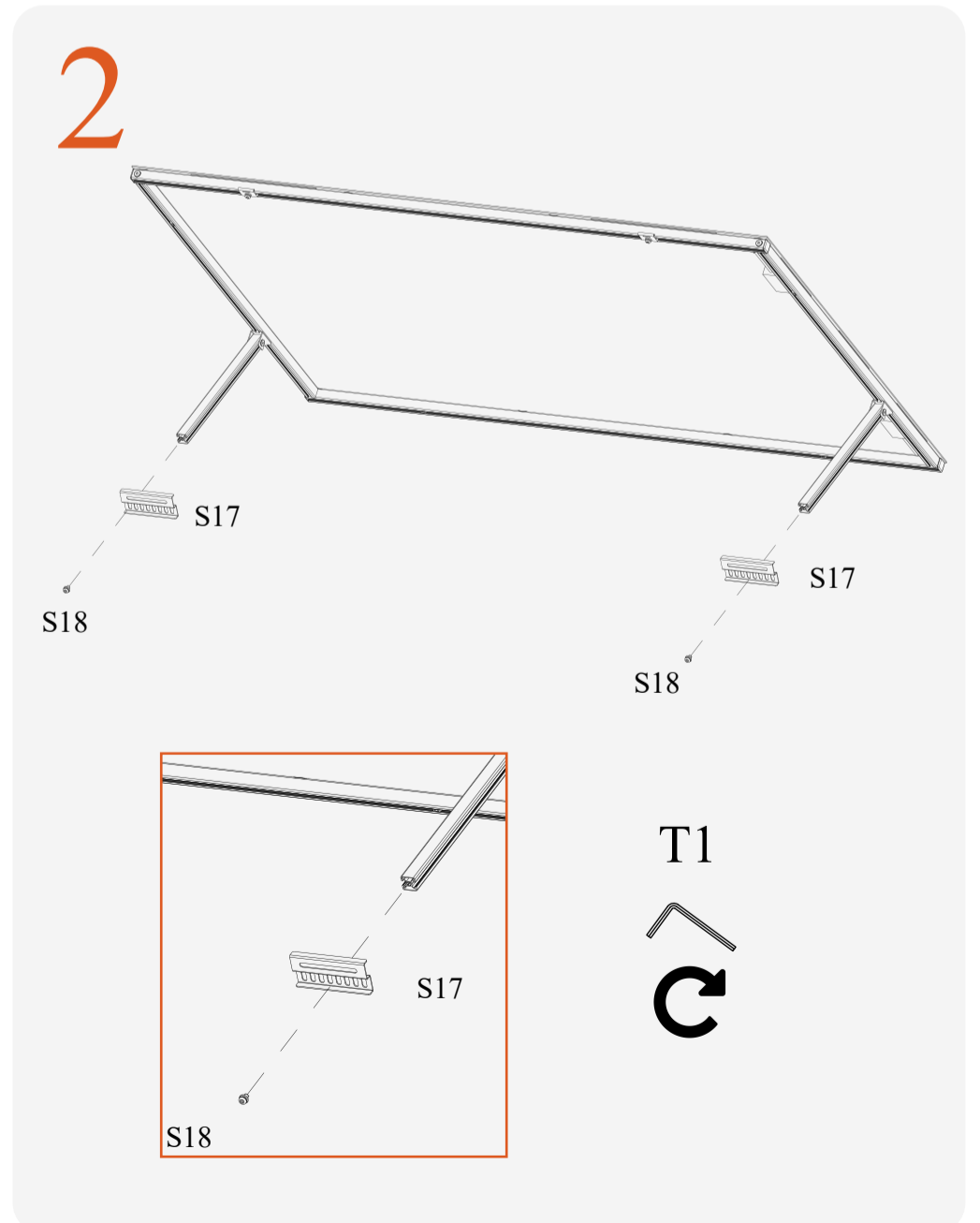
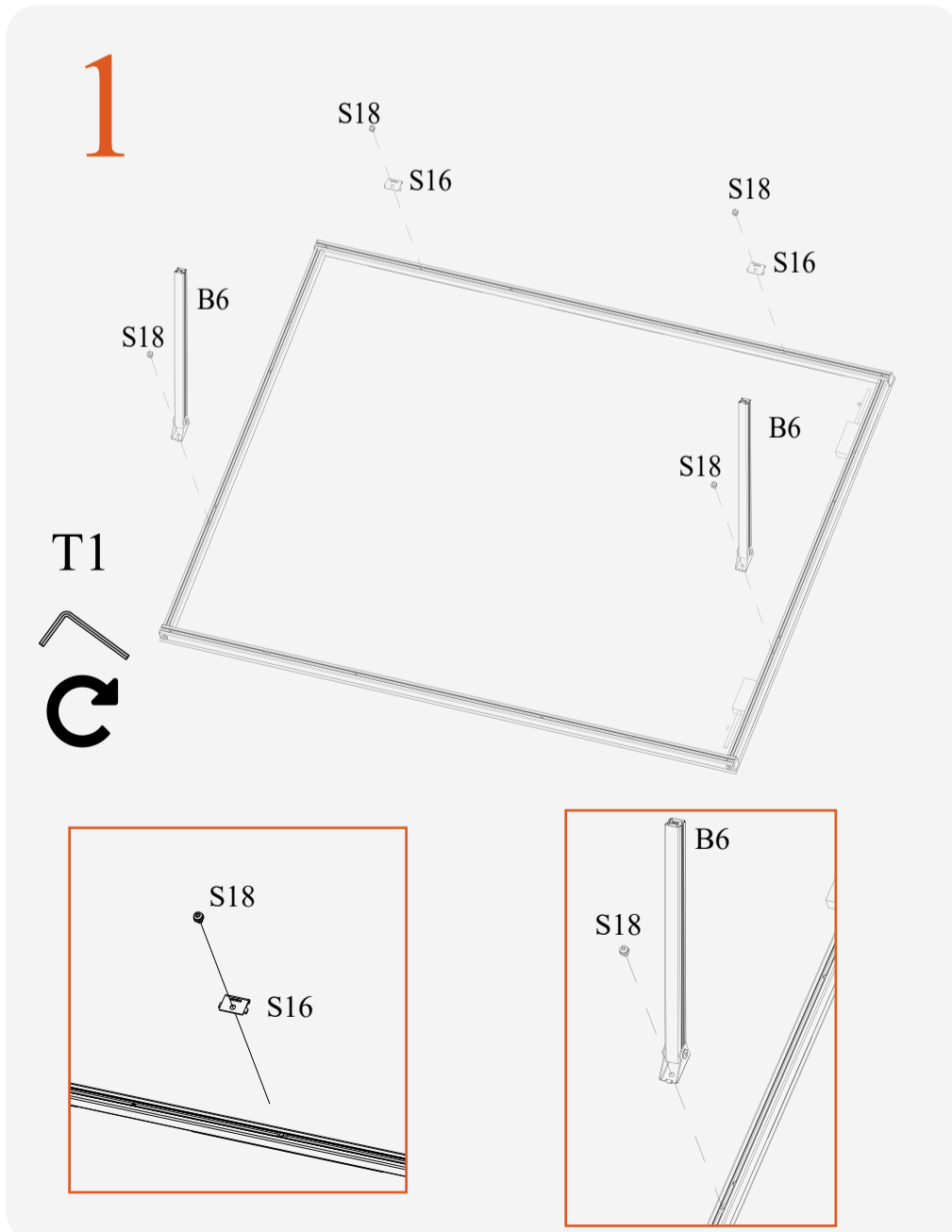

3

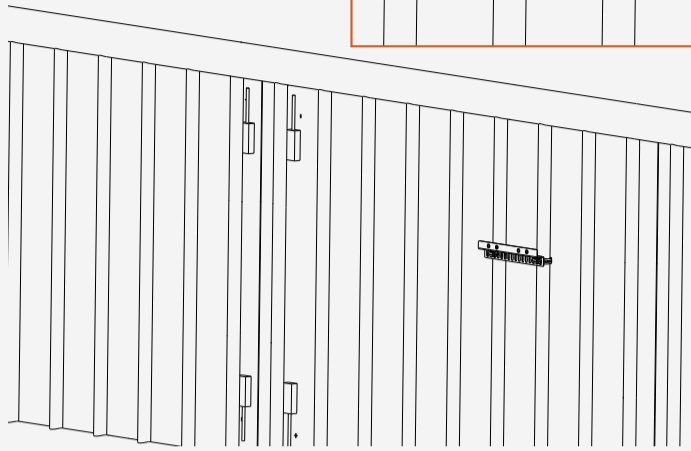
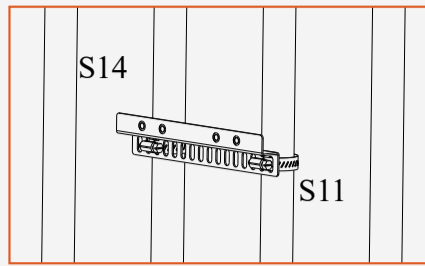

4

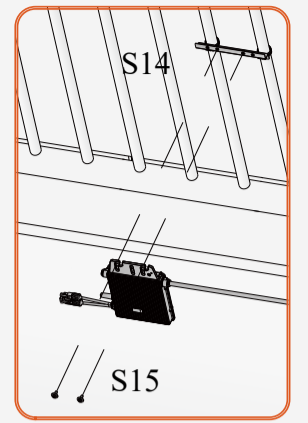
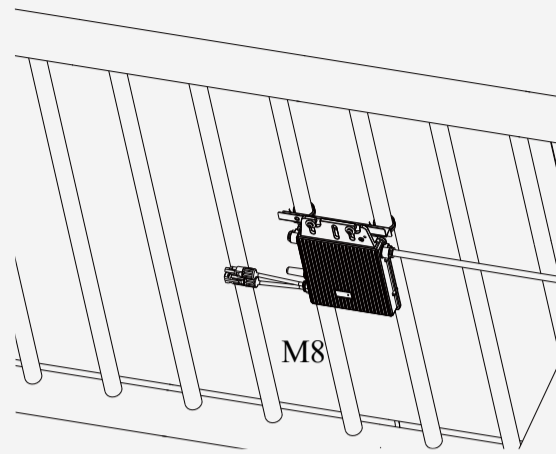

T1



5

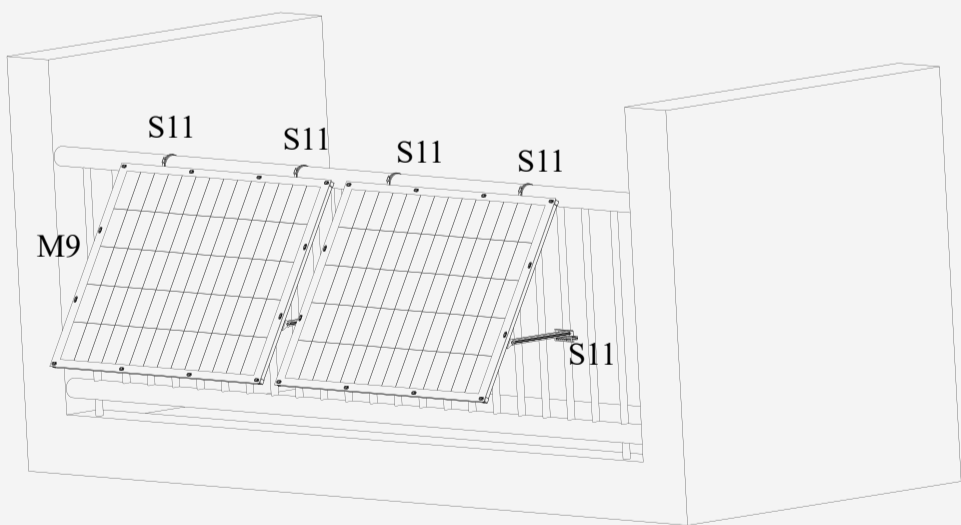
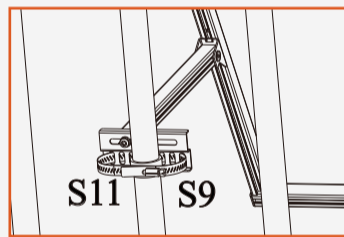
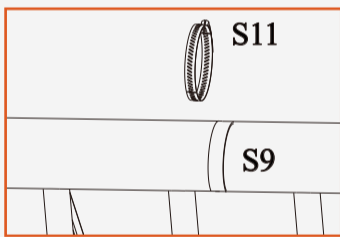
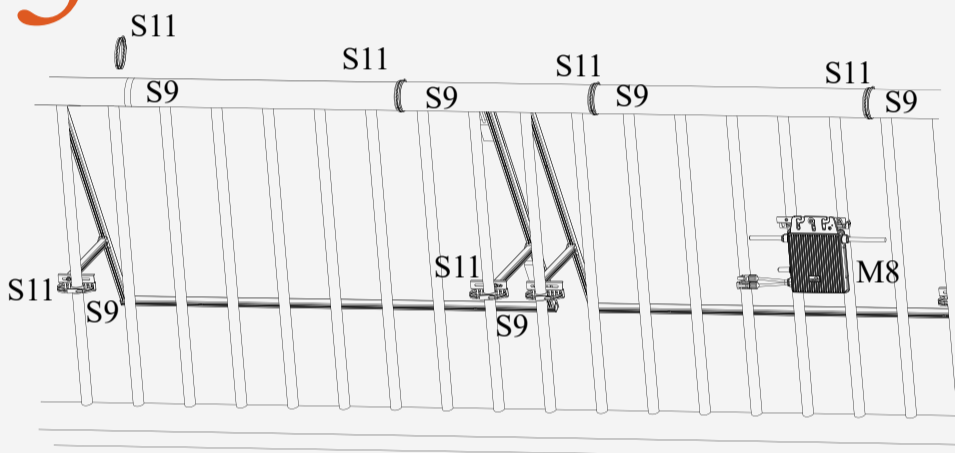

6

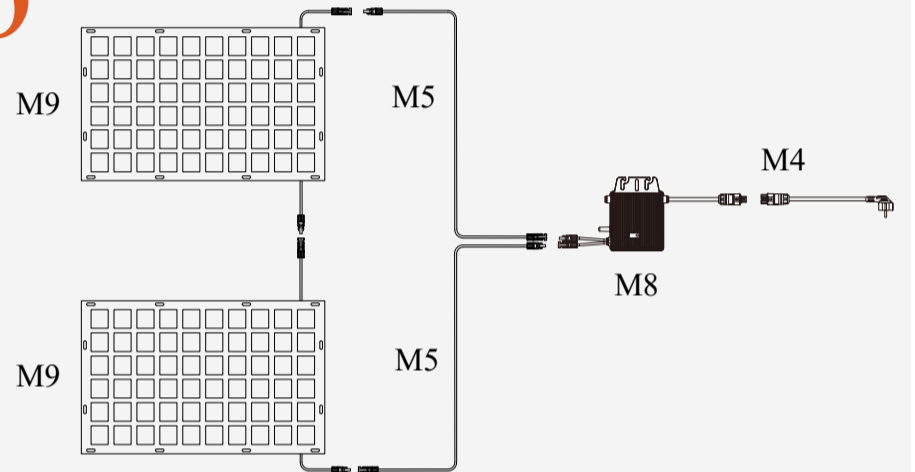

7

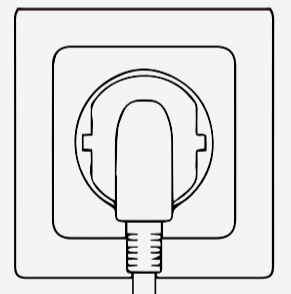
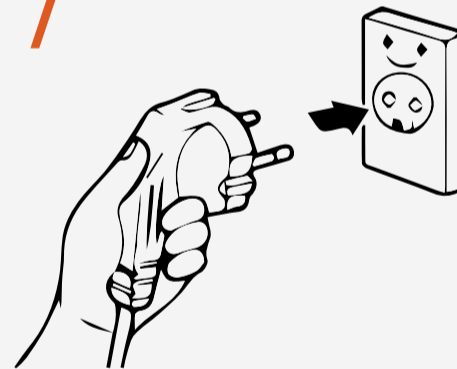

8



ESK-Conformity
of Europe



ESK Full Manual

Paste SN label here.
Fügen Sie hier das SN-Label ein.
Collez l'étiquette SN ici.
Incolla qui l'etichetta SN.
Cole o rótulo SN aqui.
Pegue la etiqueta SN aqui.
Wklej tutaj etykietę SN.
Plak hier het SN-label.

TSUNESS Co., Ltd
E-MAIL : sales@tsun-ess.com
WEB : www.tsun-ess.com
TEL : +86-512-66186028

