

User Manual

AC Coupled Unit
Hybrid Storage Unit
Storage Battery



Content

1	Notes on this Manual	2
1.1	Scope of Validity	2
1.2	Target Group	2
1.3	Symbols Used	2
2	Safety	3
2.1	Important Safety Instructions.....	3
2.2	Explanation of Symbols	4
2.3	Emergency situation	4
3	Introduction.....	6
3.1	Scope of application	6
3.2	Product Model Description.....	7
3.3	Datasheet	8
4	Installation Instructions	13
4.1	Safety Tips.....	13
4.2	Packing List	13
4.3	Determine the installation method and locatio	16
4.4	Installation steps for storage unit.....	18
4.4.1	Wall Mounting steps.....	18
4.4.2	Stacked Installation	20
5	Electrical Connections	23
5.1	Electrical Interface Description.....	23
5.2	System Wiring Schematic	24
5.3	PV Input Wring (only Hybrid).....	25
5.5	Battery Wiring	26
5.6	DRM Port Description	29
5.7	CT Installation	30
5.8	External AC Circuit Breaker and Residual Current Device	30
6	Local Configuration.....	31
6.1	Local Interface Introduction	31
6.2	Home Page.....	31
6.3	Detail Info Page	31
6.3.1	PV Info Page (only Hybrid)	31
6.3.2	Grid Info Page	32
6.3.3	Load Info Page	32
6.3.4	Battery Info Page	32
6.3.5	Inverter Info Page	32
6.4	Fault Page	33
6.5	Statistics Page	33
6.6	Setting Page.....	33
6.6.1	Brightness Setting Page	33
6.6.2	Inverter Setting Page	33
6.6.3	Version Page	39
6.6.4	Clear Page	39
6.7	Start up the System	40
6.8	Shut Down the System	40
7	Monitoring Configuration	41
7.1	Download the APP	41
7.2	Register an Account.....	41
7.3	Create a Solar Plant (Installer)	41
7.4	Add a Device (Installer).....	42
7.5	Authorize to End User (Installer)	42
7.6	Wi-Fi Configuration (Installer)	43
7.7	Login TSUN Smart and Monitor the Solar Plant (End User)	44
8	Fault Codes and Common Troubleshooting	45
9	Battery Maintenance	47
9.1	Transportation	47
9.2	Storage.....	47
9.2.1	Lithium Battery Storage	47
9.2.2	Inverter Storage	47
9.3	Cleanliness	47

1 Notes on this Manual

1.1 Scope of Validity

This manual is an integral part of TSUN Storage Unit.

AC Coupled Unit		
TSOL-ACU3.0K	TSOL-ACU3.6K	TSOL-ACU4.0K
TSOL-ACU4.6K	TSOL-ACU5.0K	TSOL-ACU6.0K
Hybrid Storage Unit		
TSOL-HSU3.0K	TSOL-HSU3.6K	TSOL-HSU4.0K
TSOL-HSU4.6K	TSOL-HSU5.0K	TSOL-HSU6.0K
Storage Battery		
TSOL-B100E-S		





This manual describes the assembly, installation, commissioning, maintenance and failure of the product. Please read it carefully before operating.

1.2 Target Group

This manual is for qualified electricians. The tasks described in this manual only can be performed by qualified personnel.





1.3 Symbols Used

The following types of safety instructions and general information appear in this document as described below:

	<p>Danger!</p> <p>“Danger” indicates a hazardous situation which, if not avoided, will result in death or serious injury.</p>
	<p>Warning!</p> <p>“Warning” indicates a hazardous situation which, if not avoided, could result in death or serious injury.</p>
	<p>Caution!</p> <p>“Caution” indicates a hazardous situation which, if not avoided, could result in minor or moderate injury.</p>
	<p>Note!</p> <p>“Note” provides tips that are valuable for the optimal operation of our product.</p>







2 Safety

2.1 Important Safety Instructions

	<p>Danger!</p> <ul style="list-style-type: none"> • Electric shock and high voltage. • Do not expose the storage unit to temperatures in excess of 45°C. • Do not subject the storage unit to any strong force. • Do not touch uninsulated cable termination. • Do not soak the storage unit in water or expose it to moisture environment. • Do not touch the case of the storage unit when it is wet in case of electric shock. • Do not dispose of batteries in fire. The batteries may explode! • Do not place the storage unit near a heat source, such as direct sunlight, a fireplace. • Keep inflammable and explosive dangerous items or flames away from the storage unit. • Do not charge or discharge damaged storage unit. • Before performing any work on the storage unit, please disconnect the storage unit from all voltage sources as described in this document.
	<p>Warning!</p> <ul style="list-style-type: none"> • Installation, repair, recycling, and disposal of storage unit must be performed by qualified personnel in accordance with national and local standards and regulations. • Risks of chemical burn electrolyte or toxic gases. • Do not place heavy objects on the top of the system. • Do not connect any un-dedicated battery pack to TSUN storage unit. • If the moisture penetrates the system (e.g., due to casing damage), please do not install or operate the system. • Do not use wet hands to touch the system. • Any behavior to change the functionality of the product without permission will cause fatal injury to the operator, third parties, and equipment. TSUNESS is not responsible for these losses and warranty claims. • To ensure property and personal safety, the batteries and inverter shall be well grounded.
	<p>Caution!</p> <ul style="list-style-type: none"> • Do not modify or tamper with storage unit and other components of the system. • Risk of injury by hoisting or falling system • Inverters and batteries are heavy and personal injury can be caused if the inverter or battery is improperly lifted or dropped during transport or improper operation when attached or removed from walls. Lifting and moved the products shall be conducted by more than one person.
	<p>Note!</p> <ul style="list-style-type: none"> • Do not extend other brands of batteries at the battery port. • Storage unit outputs AC power directly to the utility grid and the backup loads. Do not reverse output of these two AC terminals of the inverter.

2.2 Explanation of Symbols

This section explains all the symbols shown on the inverter and on the type label.

	<p>CE mark. The inverter complies with the requirements of the applicable CE guild lines.</p>
	<p>Dangerous electrical voltage The device is directly connected to public grid, thus all work to the battery shall only be carried out by qualified personnel. Do not touch any internal parts of the inverter being disconnected from the mains, battery and PV input for 5 minutes.</p>
	<p>Danger of hot surface The components inside the device will release a lot of heat during operation. Do not touch metal plate housing of the inverter during operating.</p>
	<p>Danger. Risk of electric shock!</p>
	<p>An error occurred Read the usage manual to troubleshoot problems</p>
	<p>Recyclable</p>

2.3 Emergency situation

Despite of its careful and professional protection design against any hazard results, damage of the battery may still occur. If a small amount of battery electrolyte is released due to a serious damage of the outer casing; or if the battery explodes due to not being treated timely after a fire breaks out nearby, and leaks out poisonous gases such as carbon monoxide, carbon dioxide etc., the following actions are recommended:

- 1) Eye contact: Rinse eyes with a large amount of running water and seek medical advice
- 2) Contact with skin: Wash the contacted area with soap thoroughly and seek medical advice
- 3) Inhalation: If you feel discomfort, dizziness or vomiting, seek medical advice immediately.
- 4) Use a FM-200 or Carbon Dioxide (CO₂) fire extinguishers to extinguish the fire if there is a fire in the area where the battery pack is installed. Wear a gas mask and avoid inhaling toxic gases and harmful substances produced by the fire.

- 5) Use an ABC fire extinguisher, if the fire is not caused by battery and not spread to it yet.
- 6) PV modules should have an IEC61730 class A rating.
- 7) The applicable grid types for TN-S, TN-C, TN-C-S and TT. When applied to the TT grid, the voltage of N to PE suggests less than 30V.

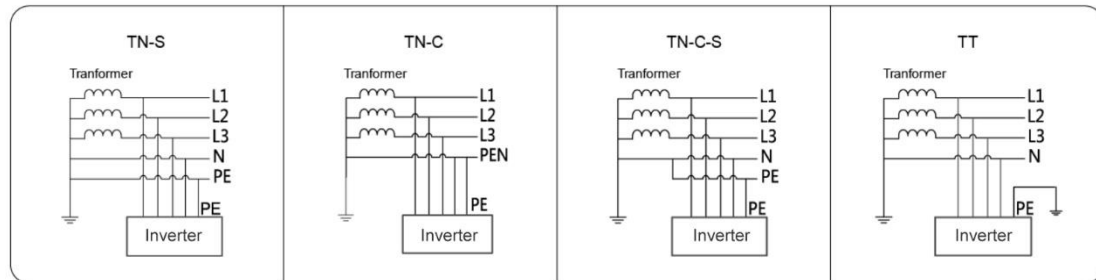

Warning!



- If a fire has just occurred, try to disconnect the battery circuit breaker and cut off the power supply first, but only if you can do so without endangering yourself.
- If the battery is on fire, do not attempt to extinguish the fire and evacuate the crowd immediately.

Potential danger of damaged battery:

Chemical Hazard: Despite of its careful and professional protection design against any hazard results, rupture of battery shall still occur due to mechanical damage, internal pressure etc., and may result in a leakage of battery electrolyte. The electrolyte is corrosive and flammable. When there is fire, the toxic gases produced will cause skin and eyes irritation, and discomfort after inhalation. Therefore:

- 1) Do not open damaged batteries.
- 2) Do not damage the battery again (shock, fall, trample, etc.).
- 3) Keep damaged batteries away from water (except to prevent an energy storage system from catching fire).
- 4) Do not expose the damaged battery to the sun to prevent internal heating of the battery.

Electrical hazard: The reason of fire and explosion accidents in lithium batteries is battery explosion. Here are the main factors of battery explosion:

- 1) Short circuit of battery. Short circuit will generate high heat inside battery, resulting in partial electrolyte gasification, which will stretch the battery shell. The temperature reaching ignition point of internal material will lead to explosive combustion.
- 2) Overcharge of battery. Overcharge of battery may precipitate lithium metal. If the shell is broken, it will come into direct contact with the air, resulting in combustion. The electrolyte will be ignited at the same time, resulting in strong flame, rapid expansion of gas and explosion.

3 Introduction

3.1 Scope of application

TSUN provide two kinds of storage unit product, AC Coupled Unit and Hybrid Storage Unit. AC Coupled Unit doesn't have PV inputs and is used in energy storage retrofits.

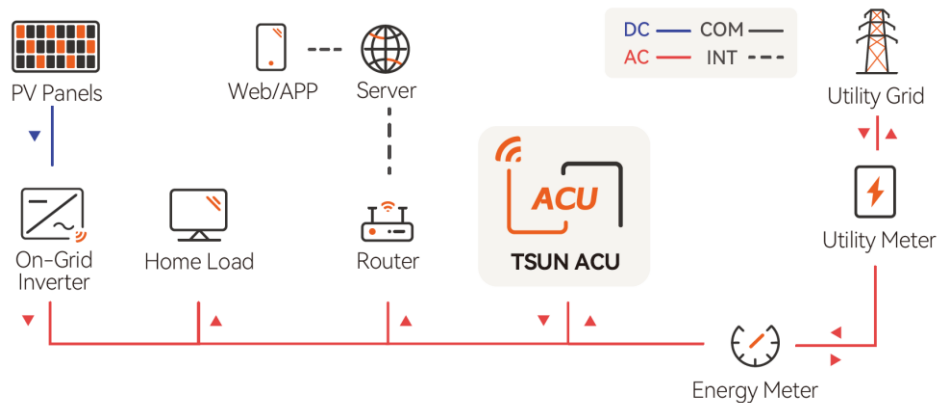

Hybrid Storage Unit has two PV inputs and is used in new installation systems.

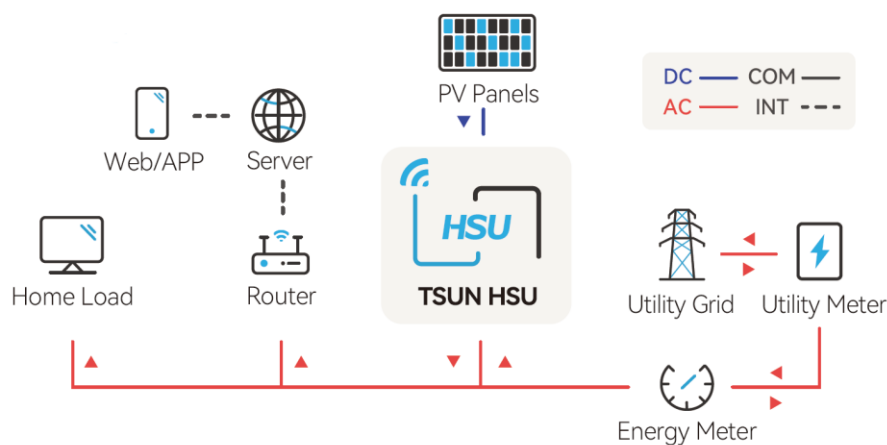

In daytime, solar power supports the loads first while the surplus power will be stored by storage unit, to improve self-consumption rate.

In peak power price hours, power from storage unit supports the loads; while in valley power price hours, storage unit is charged by the grid. Finally, a balance could be realized.

In case of grid fault, storage unit will make sure no outage in the loads, achieving UPS function.

Storage unit has two parts, inverter and battery. Storage unit can have a capacity expansion according to user demands and the modular design of the slave device makes it easy to install wiring.

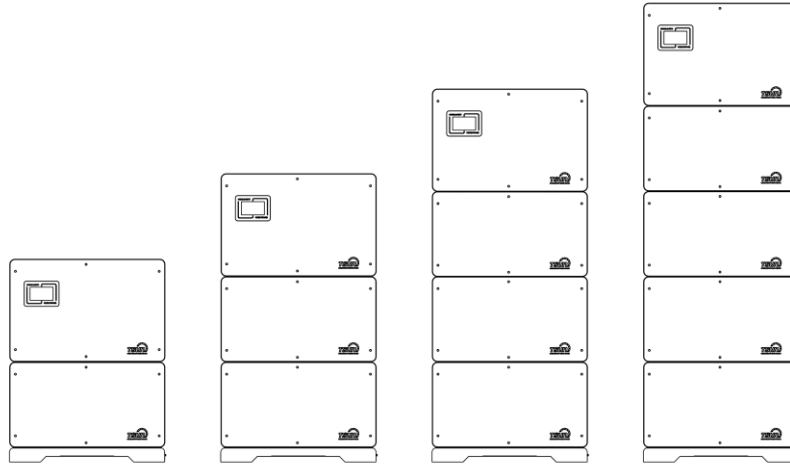

Quantity of Inverter	Quantity of Battery	System Capacity
1	1	5.12kWh
1	2	10.24kWh
1	3	15.36kWh
1	4	20.48kWh

3.2 Product Model Description

TSOL - ACU 3.0K TSOL - HSU 3.0K

① ② ③ ① ② ③

- ① TSUN product.
- ② ACU represents the AC Coupled Unit.
HSU represents the Hybrid Storage Unit.
- ③ 3.0K indicates the rated power of the product, such as 3.0K for 3KW.

TSOL - B 100 E - S

① ② ③ ④ ⑤

- ① TSUN product.
- ② B represents the storage battery.
- ③ 100 indicates the capacity of battery, such as 100 for 100Ah.
- ④ E represents the expansion battery.
- ⑤ S represents the voltage of the battery system.

3.3 Datasheet

Type	TSOL-ACU3.0K	TSOL-ACU3.6K	TSOL-ACU4.0K
Battery Data			
Battery Type	LiFePO ₄		
Battery Capacity per Kit [kWh]	5.12		
Rated Voltage [V]	51.2		
Voltage range [V]	44.8-57.6		
Depth Of Discharge [DOD]	≤90%		
Max. Charging Power [W]	3000	3680	4000
Max. Charging Current [A]	60	72	80
Max. Discharging Current [A]	60	72	80
Scalability	Yes (up to 20.48kWh)		
Grid Data			
Rated Output Power [W]	3000	3680	4000
Max. Continuable Output Power [VA]	3300	3680	4400
Rated Output Current [A]	13	16	17.4
Max. Output Current [A]	14.3	16	19.1
Rated Grid Voltage/Range [V]*	220, 230, 240, L+N+PE /180-280		
Rated Grid Frequency/Range [Hz]*	50, 60/±5		
Power factor [cos φ]	0.8 leading~0.8lagging		
THDi	<3%		
Max. inverter back feed current to the array [A]	20.5	24.5	27.3
Maximum output overcurrent protection [A]	20.5	24.5	27.3
OVC category	III		
Inrush Current [A]	42.9@3um	48@3um	57.3@3um
Maximum output fault current [A]	42.9@3um	48@3um	57.3@3um
AC Output [Back-up Mode]			
Rated output Power [W]	3000	3680	4000
Output Voltage [V]*	220/230/240		
Rated Output Current [A]	13	16	17.4
Output Frequency [Hz]*	50/60		
Peak Output Apparent Power [VA]	3300 ,60sec	4048,60sec	4400 ,60sec
General Data			
Communication Mode	Wi-Fi/4G(Optional)		
Operating Temperature Range	-30°C~+60°C		
Cooling Method	Natural Convection		
Altitude	0~2000m		
Ambient Humidity	0~100%		
Noise[dBA]	<35		
Ingress Protection	IP65		
Dimensions [H*W*D][mm]	650*428*207 (Inverter) / 650*355*207 (Battery)		
Weight [kg]	20(Inverter)/50(Battery)		
Pollution degree	II		

*The AC voltage and frequency range may vary depending on specific country grid.

Type	TSOL-ACU4.6K	TSOL-ACU5.0K	TSOL-ACU6.0K
Battery Data			
Battery Type	LiFePO ₄		
Battery Capacity per Kit [kWh]	5.12		
Rated Voltage [V]	51.2		
Voltage range [V]	44.8-57.6		
Depth Of Discharge [DOD]	≤90%		
Max. Charging Power [W]	4600	5000	6000**
Max. Charging Current [A]	92	100	120**
Max. Discharging Current [A]	92	100	120**
Scalability	Yes (up to 20.48kWh)		
Grid Data			
Rated Output Power [W]	4600	5000	6000
Max. Continuable Output Power [VA]	4600	5000	6600
Rated Output Current [A]	20	21.7	26
Max. Output Current [A]	20	21.7	28.7
Rated Grid Voltage/Range [V]*	220, 230, 240, L+N+PE /180-280		
Rated Grid Frequency/Range [Hz]*	50, 60/±5		
Power factor [cos φ]	0.8 leading~0.8lagging		
THDi	<3%		
Max. inverter back feed current to the array [A]	31.4	34.1	40.9
Maximum output overcurrent protection [A]	31.4	34.1	40.9
OVC category	III		
Inrush Current [A]	60@3um	65.1@3um	86.1@3um
Maximum output fault current [A]	60@3um	65.1@3um	86.1@3um
AC Output [Back-up Mode]			
Rated output Power [W]	4600	5000	6000**
Output Voltage [V]*	220/230/240		
Rated Output Current [A]	20	21.7	26**
Output Frequency [Hz]*	50/60		
Peak Output Apparent Power [VA]	5060 ,60sec	5500 ,60sec	6600 ,60sec
General Data			
Communication Mode	Wi-Fi/4G(Optional)		
Operating Temperature Range	-30°C~+60°C		
Cooling Method	Natural Convection		
Altitude	0~2000m		
Ambient Humidity	0~100%		
Noise[dBA]	<35		
Ingress Protection	IP65		
Dimensions [H*W*D][mm]	650*428*207 (Inverter) / 650*355*207 (Battery)		
Weight [kg]	20(Inverter)/50(Battery)		
Pollution degree	II		

*The AC voltage and frequency range may vary depending on specific country grid.

**Storage unit needs at least two batteries to reach 6000W output.

Type	TSOL-HSU3.0K	TSOL-HSU3.6K	TSOL-HSU4.0K
PV Input			
Max. PV Array Power [Wp]@STC	4500	5400	6000
Max. DC Input Voltage [V]	550		
MPPT Voltage Range [V]	80~500		
Rated DC Voltage [V]	360		
Start Voltage [V]	100		
Max. DC Input Current [A]	14/14		
Max. DC Short Circuit Current [A]	16/16		
OVC category	II		
Isc PV (absolute maximum) [A]	21	21	21
Quantity of MPPT	2		
Battery Data			
Battery Type	LiFePO ₄		
Battery Capacity per Kit [kWh]	5.12		
Rated Voltage [V]	51.2		
Voltage range [V]	44.8-57.6		
Depth Of Discharge [DOD]	≤90%		
Max. Charging Power [W]	3000	3680	4000
Max. Charging Current [A]	60	72	80
Max. Discharging Current [A]	60	72	80
Scalability	Yes (up to 20.48kWh)		
Grid Data			
Rated Output Power [W]	3000	3680	4000
Max. Continuable Output Power [VA]	3300	3680	4400
Rated Output Current [A]	13	16	17.4
Max. Output Current [A]	14.3	16	19.1
Rated Grid Voltage/Range [V]*	220, 230, 240, L+N+PE/180-280		
Rated Grid Frequency/Range [Hz]*	50, 60/±5		
Power factor [cos φ]	0.8 leading~0.8lagging		
THDi	<3%		
Max. inverter back feed current to the array [A]	20.5	24.5	27.3
Maximum output overcurrent protection [A]	20.5	24.5	27.3
OVC category	III		
Inrush Current [A]	42.9@3um	48@3um	57.3@3um
Maximum output fault current [A]	42.9@3um	48@3um	57.3@3um
AC Output [Back-up Mode]			
Rated Output Power [VA]	3000	3680	4000
Output Voltage [V]	220/230/240		
Max. Output Current [A]	13	16	17.4
Output Frequency [Hz]	50/60		
Peak Output Apparent Power [VA]	3300 ,60sec	4048 ,60sec	4400 ,60sec
General Data			
Communication Mode	Wi-Fi/4G(Optional)		
Operating Temperature Range	-30°C~+60°C		
Cooling Method	Natural Convection		

Altitude	0~2000m
Ambient Humidity	0~100%
Noise[dBA]	<35
Ingress Protection	IP65
Dimensions [H*W*D] [mm]	650*428*207 (Inverter) / 650*355*207 (Battery)
Weight [kg]	20(Inverter)/50(Battery)
Pollution degree	II

*The AC voltage and frequency range may vary depending on specific country grid.

Type	TSOL-HSU4.6K	TSOL-HSU5.0K	TSOL-HSU6.0K
PV Input			
Max. PV Array Power [Wp]@STC	6900	7500	9000
Max. DC Input Voltage [V]	550		
MPPT Voltage Range [V]	80~500		
Rated DC Voltage [V]	360		
Start Voltage [V]	100		
Max. DC Input Current [A]	14/14		
Max. DC Short Circuit Current [A]	16/16		
OVC category	II		
Isc PV (absolute maximum) [A]	21	21	21
Quantity of MPPT	2		
Battery Data			
Battery Type	LiFePO ₄		
Battery Capacity per Kit [kWh]	5.12		
Rated Voltage [V]	51.2		
Voltage range [V]	44.8-57.6		
Depth Of Discharge [DOD]	≤90%		
Max. Charging Power [W]	4600	5000	6000**
Max. Charging Current [A]	92	100	120**
Max. Discharging Current [A]	92	100	120**
Scalability	Yes (up to 20.48kWh)		
Grid Data			
Rated Output Power [W]	4600	5000	6000
Max. Continuable Output Power [VA]	4600	5000	6600
Rated Output Current [A]	20	21.7	26
Max. Output Current [A]	20	21.7	28.7
Rated Grid Voltage/Range [V]*	220, 230, 240, L+N+PE /180-280		
Rated Frequency/Range [Hz]*	50, 60/±5		
Power factor [cos φ]	0.8 leading~0.8lagging		
THDi	<3%		
Max. inverter back feed current to the array [A]	31.4	34.1	40.9
Maximum output overcurrent protection [A]	31.4	34.1	40.9
OVC category	III		
Inrush Current [A]	60@3um	65.1@3um	86.1@3um
Maximum output fault current [A]	60@3um	65.1@3um	86.1@3um

AC Output [Back-up Mode]			
Rated Output Power [VA]	4600	5000	6000**
Output Voltage [V]*	220/230/240		
Max. Output Current [A]	20	21.7	26**
Output Frequency [Hz]*	50/60		
Max. Output Power [VA]	5060 ,60sec	5500 ,60sec	6600 ,60sec
General Data			
Communication Mode	Wi-Fi/4G(Optional)		
Operating Temperature Range	-30°C~+60°C		
Cooling Method	Natural Convection		
Altitude	0~2000m		
Ambient Humidity	0~100%		
Noise[dBA]	<35		
Ingress Protection	IP65		
Dimensions [H*W*D] [mm]	650*428*207 (Inverter) / 650*355*207 (Battery)		
Weight [kg]	20(Inverter)/50(Battery)		
Pollution degree	II		

*The AC voltage and frequency range may vary depending on specific country grid.

**Storage unit needs at least two batteries to reach 6000W output.

Type	TSOL-B100E-S
Electrical Parameter	
Battery Type	LiFePO ₄
Battery Capacity per Kit [Wh]	5120
Usable Energy [Wh]	4600
Rated Voltage [V]	51.2
Voltage range [V]	44.8-57.6
Max. Charging and Discharging Rate	1C
Depth Of Discharge [DOD]	≤90%
Cycle Life(25°C,0.5C)	≥6000 times,80% Capacity retention
General Data	
Communication Mode	RS485/CAN2.0
Operating Temperature Range	0~50°C (Charge)/-10~50°C(Discharge)
Storage Temperature Range	-15°C~+60°C
Cooling Method	Natural Convection
Altitude	<2000m
Ambient Humidity	0-100% non-condensing
Noise[dBA]	<25
Ingress Protection	IP65
Dimensions [H*W*D][mm]	650*355*207
Weight [kg]	49

4 Installation Instructions

4.1 Safety Tips



Danger!

- Potential fires and electric shocks that are life threatening.
- Do not place any flammable or explosive materials beside storage unit.
- Equipment connected to high-voltage power generation equipment must be performed by qualified personnel in compliance with national and local standards and regulations.











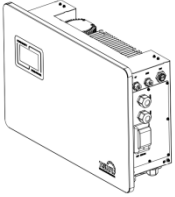









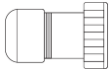

Note!

- The pollution level applicable to storage unit is Class II.
- Inappropriate or inconsistent installation environment can shorten the life of storage unit.
- Do not install storage unit directly by exposing it under strong sunlight.
- Please do not install in damp places.
- The installation location must be well ventilated.
- Storage unit (hereinafter also referred to as the master device) can be used with one battery. If the battery capacity needs to be expanded, please use TSOL-B100E-S (slave device), and maximum 4 batteries are supported for the whole system.

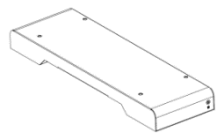



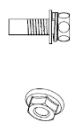



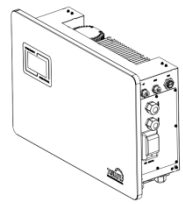

4.2 Packing List

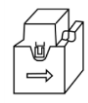

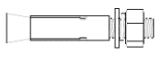
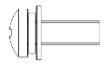

Hybrid Storage Unit (Inverter)

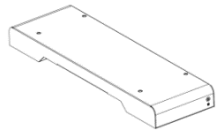
			
1* HCU(Inverter)	1* User Manual	1* Monitor Module	1* CT
			
2* Mounting Bracket	4* Expansion screw	9* Assembling Bolt	6* OT Terminals Bracket)
			
2* PV+ input terminal	2* PV- input terminal	2* Secured Metal terminals to PV+ input power cables	2* Secured Metal terminals to PV- input power cables





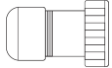





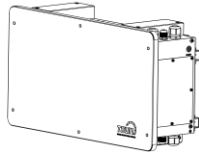

			
2* Waterproof terminal	2* Waterproof rubber ring	2* Plug	1* Base
			
4* Guide pin	1* Mounting Bracket	1* Positioning Bracket	4* M5-15 Assembling Bolt, 4* M5 Hexagon nuts with flange (To fix Positioning Bracket)
			
1* Packing List		1* Qualified Certificate	

AC Coupled Unit (Inverter)

			
1* ACU(Inverter)	1* User Manual	1* Monitor Module	1* CT
			
2* Mounting Bracket	4* Expansion screw	9* Assembling Bolt	6* OT Terminals Bracket)
			
2* Waterproof rubber ring	2* Plug	1* Base	4* Guide pin

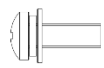
			
1* Mounting Bracket	1* Positioning Bracket	4* M5-15 Assembling Bolt, 4* M5 Hexagon nuts with flange (To fix Positioning Bracket)	2* Waterproof terminal
			
1* Packing List		1* Qualified Certificate	

Storage Battery (Battery)

			
1* Battery	1* Mounting Bracket	2* Mounting Bracket	4* Expansion screw (M6)
			
1* Grounding Cable	2* BAT+ and BAT - Cable	2* RJ-45 plug	1* Communication cable
			
10* Assembling Bolt	4* Guide pin	1* Packing List	1* Qualified Certificate

4.3 Determine the installation method and location

Inverter dimension:

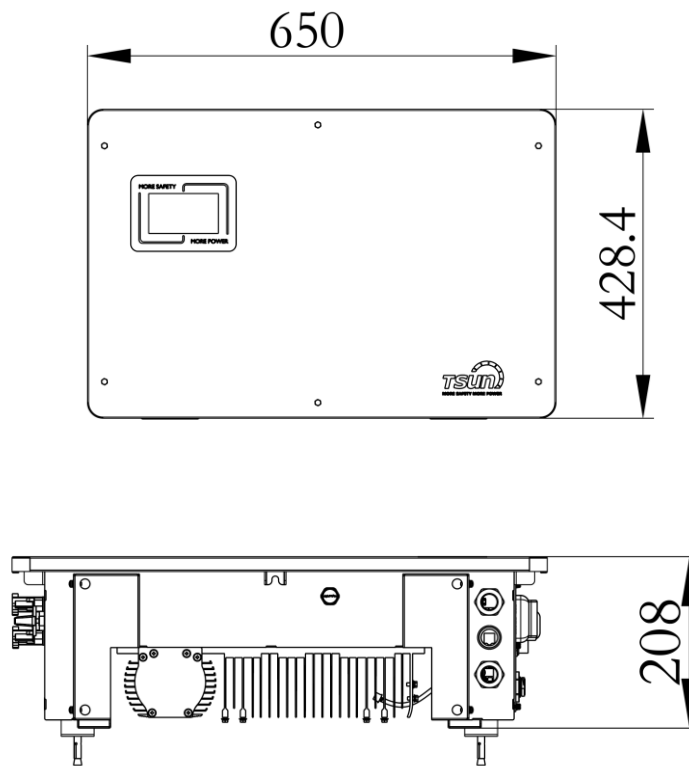

Battery dimension:

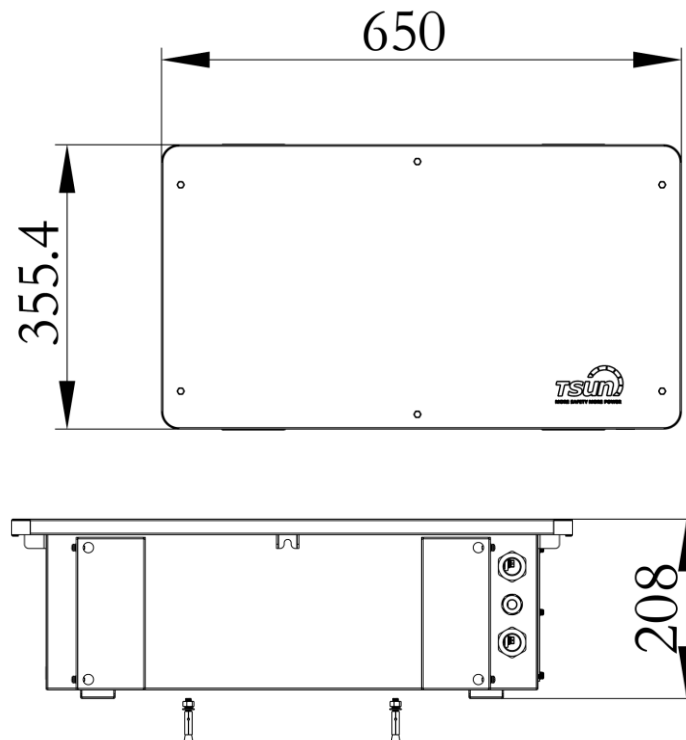

Storage unit is cooled by natural wind convection. It is recommended to install in areas which avoid direct sunlight, rain and snow.

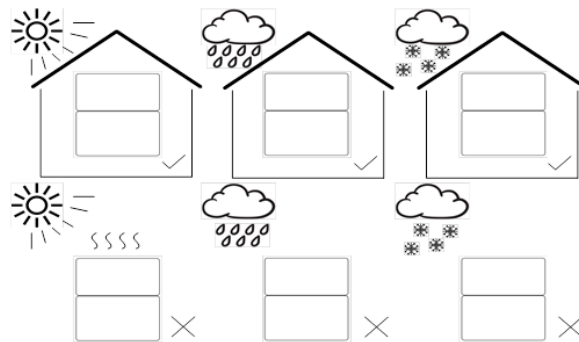

Vertical ground mounting method is recommended and it's allowed to be installed by maximum tilting 15° backward. Do not install it horizontally or reversely.

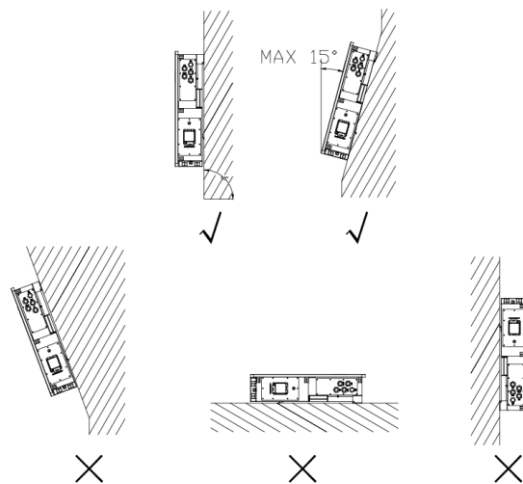

Please ensure that the air at the installation point is circulated. Bad air ventilation will affect the working performance of internal electronic components and shorten the service life of storage unit.

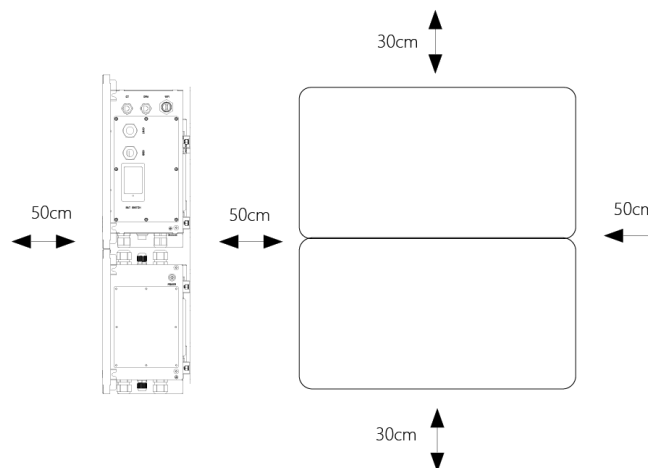

The following sites are not allowed for installation:

- within 600mm of any exit.
- within 600mm of any vertical side of a window or building ventilation that ventilates a habitable room.
- in ceiling spaces.
- in wall cavities or under stairways.
- on roofs, except for were specially deemed suitable.
- under access walkways.
- sites where the freezing point is reached, like garages, carports or other places.
- places with plenty of salt.
- flooded areas.
- within 600mm of any hot water unit, air conditioning unit or any other appliance associated with the pre-assembled integrated battery energy storage system

4.4 Installation steps for storage unit

4.4.1 Wall Mounting steps

Note!



- If there are more than one unit of storage battery connected to the inverter, please install battery No.4 first, battery No.3 secondly, battery No.2 thirdly, battery No.1 fourthly and inverter finally, from bottom to top.
- Before installation, please make sure that the wall has sufficient strength to fix the screws and bear the weight of inverter and battery.

Step 1: Pre-check the installation distance of the inverter and battery to other items.

Step 2: Use the positioning bracket to fix two mounting brackets.

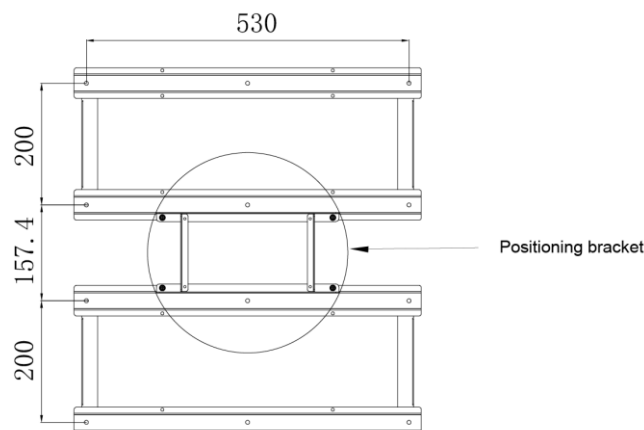

Note!



- Every storage unit provide a positioning bracket. Use this positioning bracket to keep the same distance between every two mounting brackets.

Step 3: Positioning the Mounting bracket to the wall. Mark the proper positions of mounting bracket and drill holes on those positions (8mm in diameter, 50mm in depth) by using the mounting bracket as a template, and then use a rubber hammer to drive the screw fixing seat into the holes to fix the bracket.

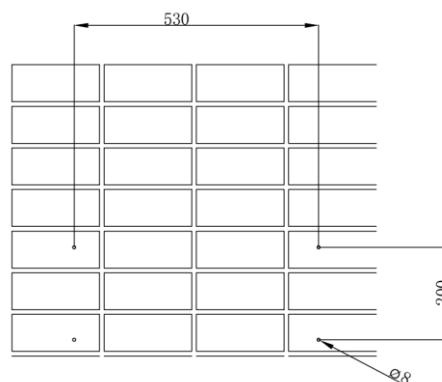

Step 3: Fix the mounting bracket with expansion screw on the installation positions, and then take away the positioning bracket.

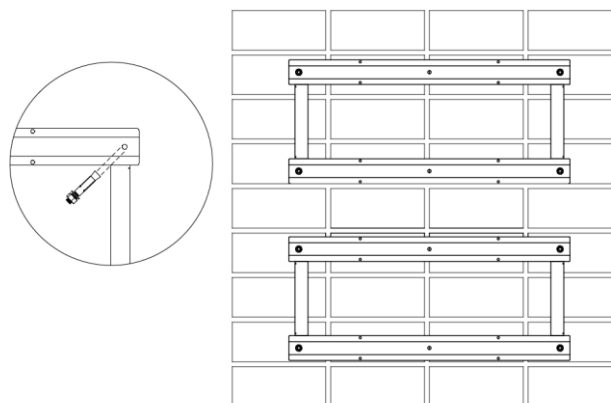

Note!



- If more than one battery needs to be installed, follow above steps to install battery mounting brackets.

Step 4: Before hanging the inverter and battery on the mounting bracket, please remove the plug from the waterproof nut of the inverter and battery, then put on the cable gland but not tighten it up yet.

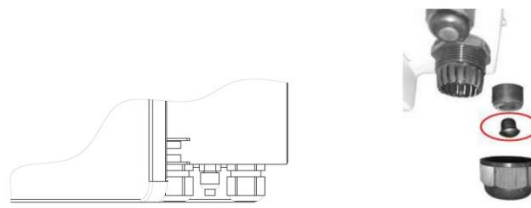

Step 5: Hang the inverter and battery to the mounting bracket and make sure the device is snugly fits with the bracket.

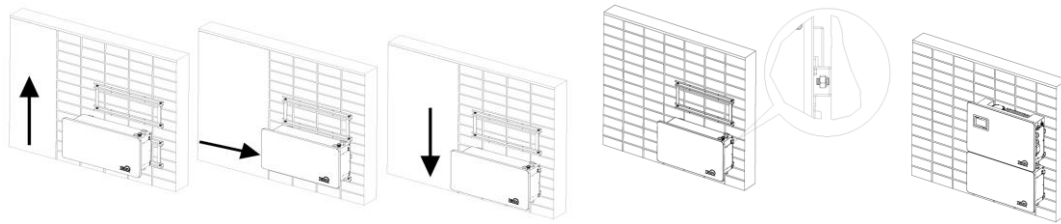

4.4.2 Stacked Installation

Step 1: Mark the correct positions of the mounting brackets according to the positions and dimensions marked in the illustration below, drill holes (8 mm diameter, 50 mm depth) in these positions and then drive the screw mounts into the holes using a rubber mallet.

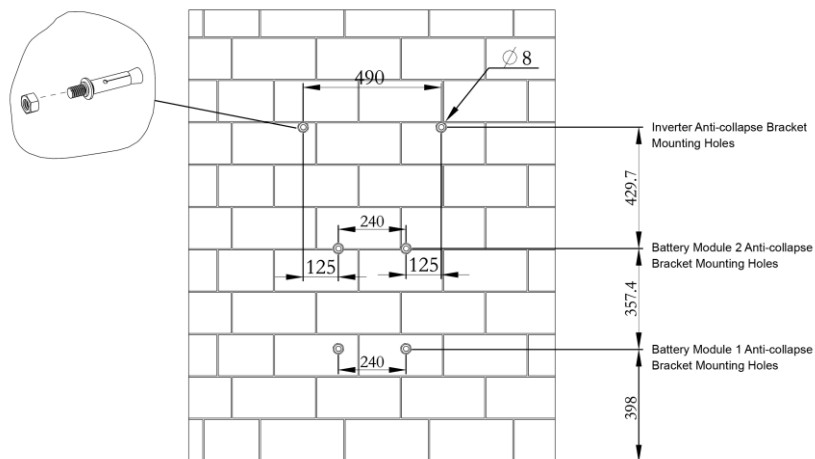

Step 2: Remove the base from the carton and install the four locating pin screws clockwise.

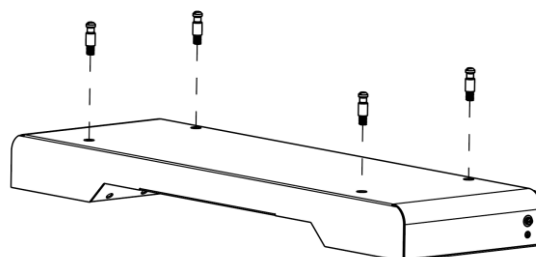

Step 3: Place the base against a wall on a level surface and make sure the base is horizontal.

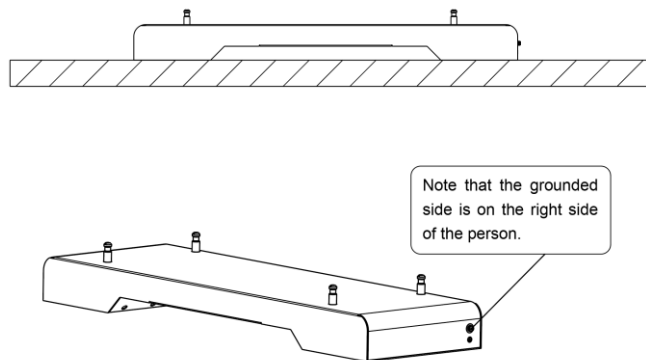

Step 4: Remove the Battery Packs from the carton and install the four locating pin screws clockwise.

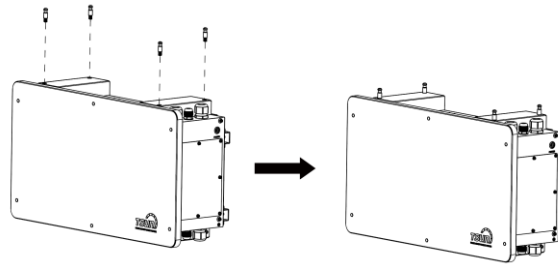

Step 5: Lift the battery box to mount it on the base and lock the 4 locating pins with screws.

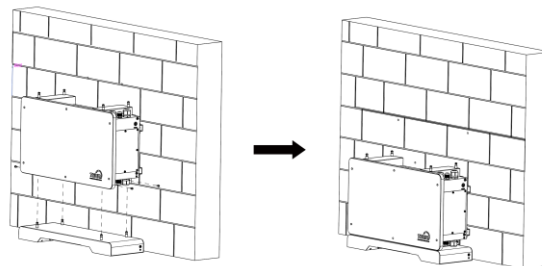

Step 6: Installation of anti-collapse brackets

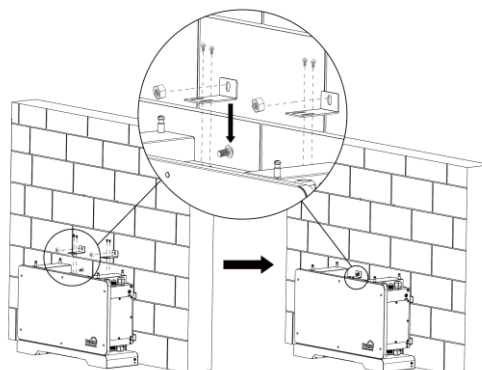

Step 7: Repeat the same way to install more battery packs

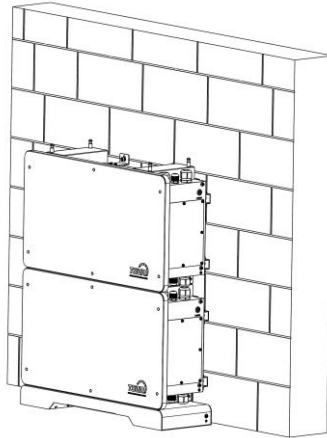

Step 8: Lift the inverter, install it on the battery pack and lock the locating pin screws

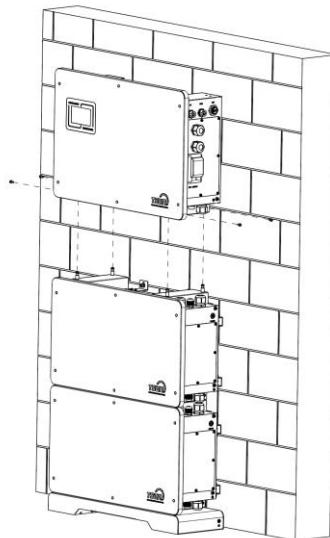

Step 9: Installation of inverter anti-collapse brackets. Installation complete.

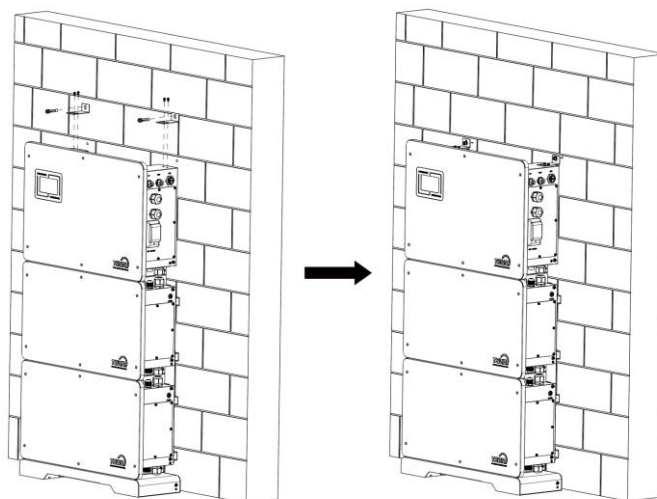

5 Electrical Connections

5.1 Electrical Interface Description

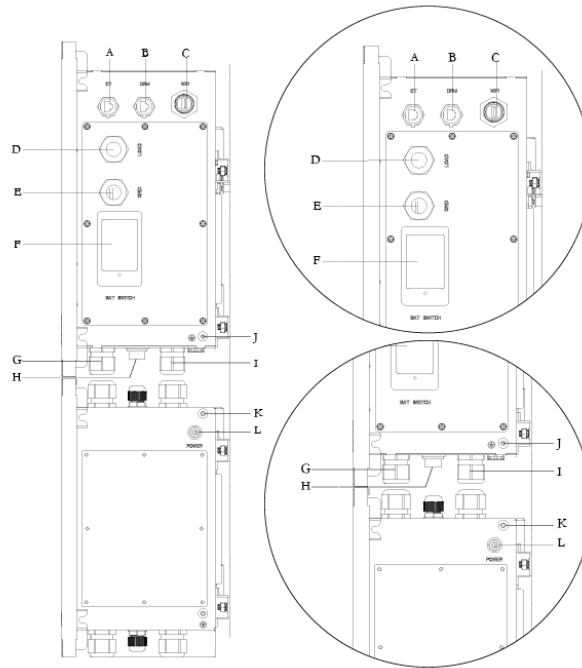

Object	Description	Object	Description
A	CT Port	G	BAT+ Wire Hole
B	DRMs Port	H	BMS LINK-OUT
C	WiFi Port	I	BAT- Wire Hole
D	Load Connection	J	ACU Grounding
E	Grid Connection	K	Battery PE
F	Battery Switch	L	Battery Power Button

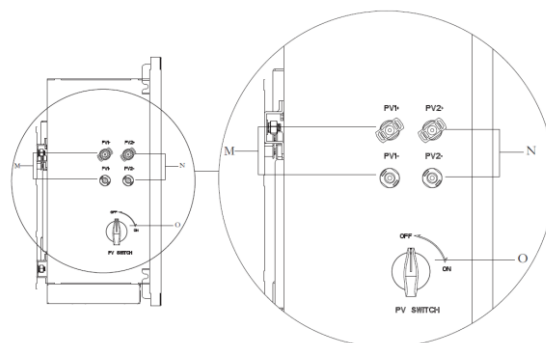

Object	Description	Object	Description
M	PV1 input (only Hybrid)	N	PV2 input (only Hybrid)
O	DC Switch (only Hybrid)		

5.2 System Wiring Schematic

AC Coupled Unit:

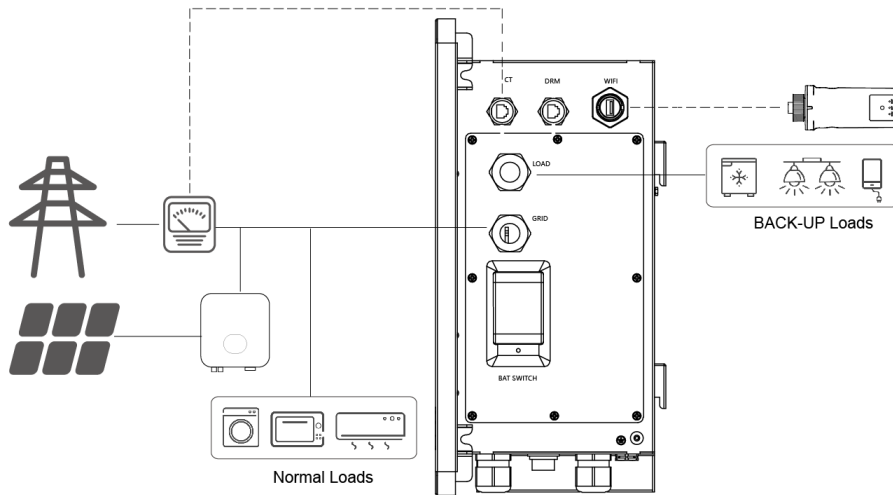

Hybrid Storage Unit:

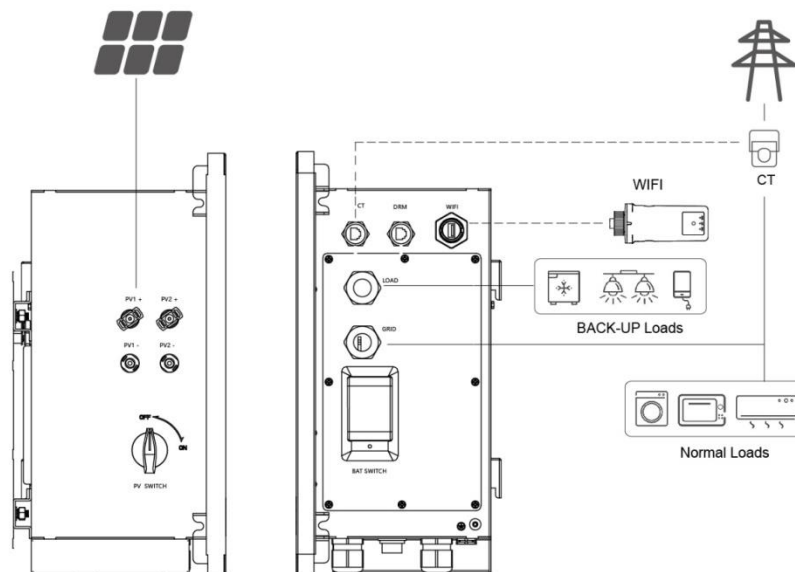

Warning!

- Don't connect the backup loads side with the grid or battery



BACKUP

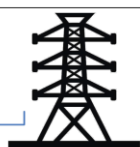
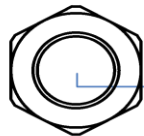

BACKUP

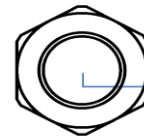

5.3 PV Input Wiring (only Hybrid)

Note!

- Use 4 mm² DC cable for the DC input cable.

Step 1: Prepare PV positive and negative power cables;



1. Positive connector 2. Negative connector

Step 2: Insert the crimped photovoltaic positive and negative power cable into the corresponding photovoltaic connector.

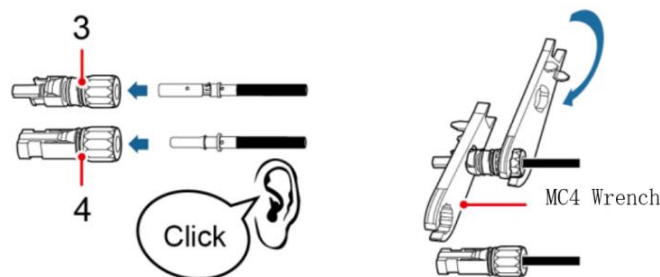

3. Positive connector 4. Negative connector

Step 3: Insert the positive and negative connectors into the corresponding PV region of the HSU unit until a click is heard.

Warning!

- Make sure that the DC voltage of each PV string is less than 550V and the polarity of PV cables are correct.
- Make sure that the DC switch should be turned off.

5.4 AC Output Wiring

Warning!

- Turn off the Battery Switch and external AC breaker after unpacking in any cases before and during wiring in case of electric shock.
- Please be cautious when unplug battery switch cable during dismantling.

Step 1: Unscrew the screws and remove the cover plate of inverter.

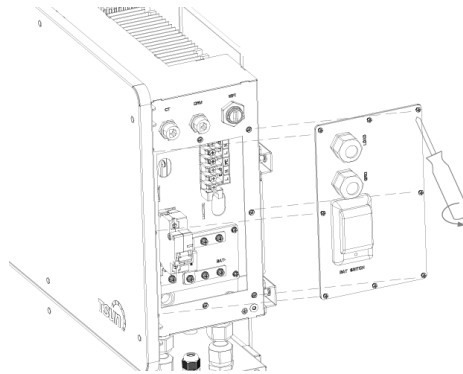

Step 2: Lead one cable through the waterproof nut (GRID) and then connect the wires to the terminal of GRIDL, GRIDN and PE properly.

Note!



- Use 2.5 mm² AC cable for the AC output cable.
- According to the actual request, switch the 3-hole/single-hole water-draining rubber ring

Step 3: Lead another cable through the waterproof nut (LOAD) and then connect the wires to the terminal of LOAD-L, LOAD-N and PE accordingly.

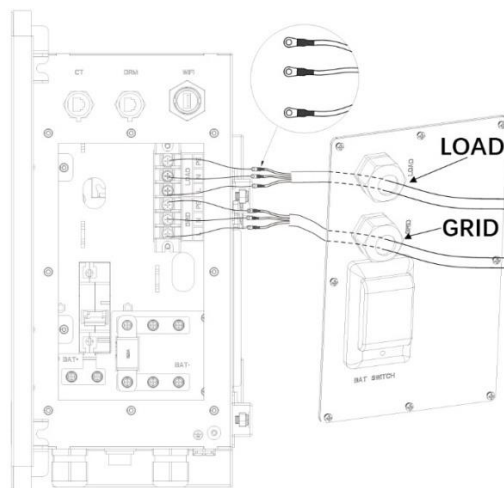

5.5 Battery Wiring

Warning!



- The Batteries are paralleled to the inverter.
- Ensure Battery switch is off during installation to avoid the risk of short circuit caused by wrong operation during battery wiring.
- Do not connect one Expansion Battery to two different ACU devices at the same time

Step 1: Unscrew the screws and remove the cover plate of battery.

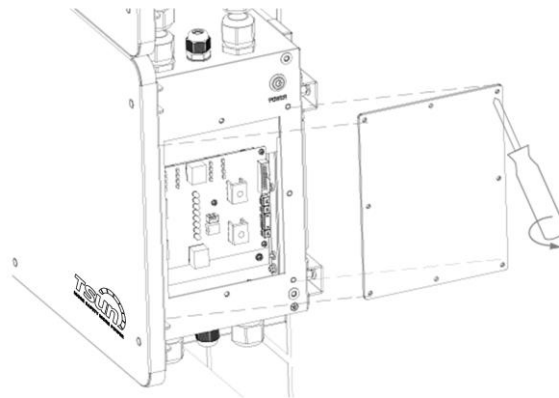

Step 2: Lead battery cables through the waterproof nuts of the inverter and battery respectively, make sure the cables are connected correctly (BAT+ of inverter to BAT+ of battery, BAT- of inverter to BAT- of battery).

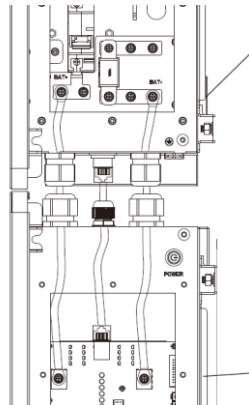

Step 3: Use a network cable clamp, lead the RJ45 communication cable through the waterproof nut of battery. Connect this cable from the communication port of inverter to the LINK-IN port of Battery. When using it, you need to insert the communication cable into the RJ-45 Plug, and then use a special tool to crimp.



Pin Number	Effect	Pin Number	Effect
1	485 B	5	CAN L
2	485 A	6	NC
3	NC	7	NC
4	CAN H	8	NC

Step 4: If there are more than one battery, lead battery cables through the waterproof nuts of two batteries respectively, make sure the cables are connected correctly (BAT+ to BAT+, BAT- to BAT-). And lead the RJ45 communication cable through the waterproof nuts of batteries. Connect this cable from the LINK-OUT port of Battery 1 to the LINK-IN port of Battery 2.

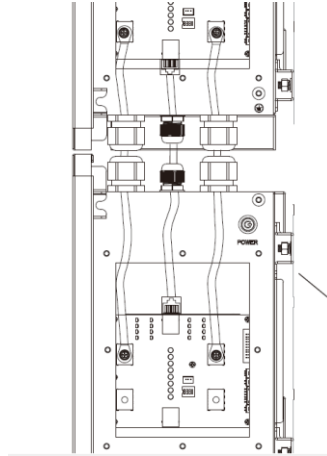

Step 5: Set the DIP switch of each battery.

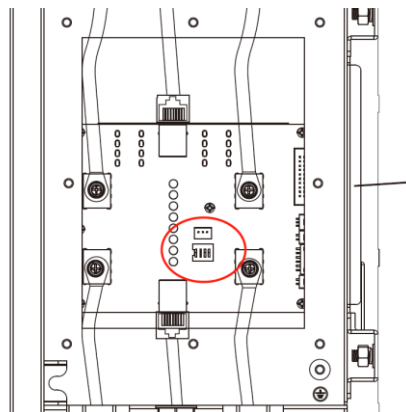

DIP switch configuration can be found below:

Configuration	Battery (No.1)	Battery (No.2)	Battery (No.3)	Battery (No.4)																																																
1*Inverter 1* Battery	<table border="1"> <tr> <td>NO</td> <td>KE</td> <td></td> <td></td> </tr> <tr> <td><input type="checkbox"/></td> <td><input type="checkbox"/></td> <td><input type="checkbox"/></td> <td><input type="checkbox"/></td> </tr> <tr> <td>1</td> <td>2</td> <td>3</td> <td>4</td> </tr> </table>	NO	KE			<input type="checkbox"/>	<input type="checkbox"/>	<input type="checkbox"/>	<input type="checkbox"/>	1	2	3	4																																							
NO	KE																																																			
<input type="checkbox"/>	<input type="checkbox"/>	<input type="checkbox"/>	<input type="checkbox"/>																																																	
1	2	3	4																																																	
1*Inverter 2* Battery	<table border="1"> <tr> <td>NO</td> <td>KE</td> <td></td> <td></td> </tr> <tr> <td><input type="checkbox"/></td> <td><input type="checkbox"/></td> <td><input type="checkbox"/></td> <td><input type="checkbox"/></td> </tr> <tr> <td>1</td> <td>2</td> <td>3</td> <td>4</td> </tr> </table>	NO	KE			<input type="checkbox"/>	<input type="checkbox"/>	<input type="checkbox"/>	<input type="checkbox"/>	1	2	3	4	<table border="1"> <tr> <td>NO</td> <td>KE</td> <td></td> <td></td> </tr> <tr> <td><input type="checkbox"/></td> <td><input type="checkbox"/></td> <td><input type="checkbox"/></td> <td><input type="checkbox"/></td> </tr> <tr> <td>1</td> <td>2</td> <td>3</td> <td>4</td> </tr> </table>	NO	KE			<input type="checkbox"/>	<input type="checkbox"/>	<input type="checkbox"/>	<input type="checkbox"/>	1	2	3	4																										
NO	KE																																																			
<input type="checkbox"/>	<input type="checkbox"/>	<input type="checkbox"/>	<input type="checkbox"/>																																																	
1	2	3	4																																																	
NO	KE																																																			
<input type="checkbox"/>	<input type="checkbox"/>	<input type="checkbox"/>	<input type="checkbox"/>																																																	
1	2	3	4																																																	
1*Inverter 3* Battery	<table border="1"> <tr> <td>NO</td> <td>KE</td> <td></td> <td></td> </tr> <tr> <td><input type="checkbox"/></td> <td><input type="checkbox"/></td> <td><input type="checkbox"/></td> <td><input type="checkbox"/></td> </tr> <tr> <td>1</td> <td>2</td> <td>3</td> <td>4</td> </tr> </table>	NO	KE			<input type="checkbox"/>	<input type="checkbox"/>	<input type="checkbox"/>	<input type="checkbox"/>	1	2	3	4	<table border="1"> <tr> <td>NO</td> <td>KE</td> <td></td> <td></td> </tr> <tr> <td><input type="checkbox"/></td> <td><input type="checkbox"/></td> <td><input type="checkbox"/></td> <td><input type="checkbox"/></td> </tr> <tr> <td>1</td> <td>2</td> <td>3</td> <td>4</td> </tr> </table>	NO	KE			<input type="checkbox"/>	<input type="checkbox"/>	<input type="checkbox"/>	<input type="checkbox"/>	1	2	3	4	<table border="1"> <tr> <td>NO</td> <td>KE</td> <td></td> <td></td> </tr> <tr> <td><input type="checkbox"/></td> <td><input type="checkbox"/></td> <td><input type="checkbox"/></td> <td><input type="checkbox"/></td> </tr> <tr> <td>1</td> <td>2</td> <td>3</td> <td>4</td> </tr> </table>	NO	KE			<input type="checkbox"/>	<input type="checkbox"/>	<input type="checkbox"/>	<input type="checkbox"/>	1	2	3	4													
NO	KE																																																			
<input type="checkbox"/>	<input type="checkbox"/>	<input type="checkbox"/>	<input type="checkbox"/>																																																	
1	2	3	4																																																	
NO	KE																																																			
<input type="checkbox"/>	<input type="checkbox"/>	<input type="checkbox"/>	<input type="checkbox"/>																																																	
1	2	3	4																																																	
NO	KE																																																			
<input type="checkbox"/>	<input type="checkbox"/>	<input type="checkbox"/>	<input type="checkbox"/>																																																	
1	2	3	4																																																	
1*Inverter 4* Battery	<table border="1"> <tr> <td>NO</td> <td>KE</td> <td></td> <td></td> </tr> <tr> <td><input type="checkbox"/></td> <td><input type="checkbox"/></td> <td><input type="checkbox"/></td> <td><input type="checkbox"/></td> </tr> <tr> <td>1</td> <td>2</td> <td>3</td> <td>4</td> </tr> </table>	NO	KE			<input type="checkbox"/>	<input type="checkbox"/>	<input type="checkbox"/>	<input type="checkbox"/>	1	2	3	4	<table border="1"> <tr> <td>NO</td> <td>KE</td> <td></td> <td></td> </tr> <tr> <td><input type="checkbox"/></td> <td><input type="checkbox"/></td> <td><input type="checkbox"/></td> <td><input type="checkbox"/></td> </tr> <tr> <td>1</td> <td>2</td> <td>3</td> <td>4</td> </tr> </table>	NO	KE			<input type="checkbox"/>	<input type="checkbox"/>	<input type="checkbox"/>	<input type="checkbox"/>	1	2	3	4	<table border="1"> <tr> <td>NO</td> <td>KE</td> <td></td> <td></td> </tr> <tr> <td><input type="checkbox"/></td> <td><input type="checkbox"/></td> <td><input type="checkbox"/></td> <td><input type="checkbox"/></td> </tr> <tr> <td>1</td> <td>2</td> <td>3</td> <td>4</td> </tr> </table>	NO	KE			<input type="checkbox"/>	<input type="checkbox"/>	<input type="checkbox"/>	<input type="checkbox"/>	1	2	3	4	<table border="1"> <tr> <td>NO</td> <td>KE</td> <td></td> <td></td> </tr> <tr> <td><input type="checkbox"/></td> <td><input type="checkbox"/></td> <td><input type="checkbox"/></td> <td><input type="checkbox"/></td> </tr> <tr> <td>1</td> <td>2</td> <td>3</td> <td>4</td> </tr> </table>	NO	KE			<input type="checkbox"/>	<input type="checkbox"/>	<input type="checkbox"/>	<input type="checkbox"/>	1	2	3	4
NO	KE																																																			
<input type="checkbox"/>	<input type="checkbox"/>	<input type="checkbox"/>	<input type="checkbox"/>																																																	
1	2	3	4																																																	
NO	KE																																																			
<input type="checkbox"/>	<input type="checkbox"/>	<input type="checkbox"/>	<input type="checkbox"/>																																																	
1	2	3	4																																																	
NO	KE																																																			
<input type="checkbox"/>	<input type="checkbox"/>	<input type="checkbox"/>	<input type="checkbox"/>																																																	
1	2	3	4																																																	
NO	KE																																																			
<input type="checkbox"/>	<input type="checkbox"/>	<input type="checkbox"/>	<input type="checkbox"/>																																																	
1	2	3	4																																																	

Step 6: Use a wrench to fasten cable gland of the inverter and battery (30kgf.cm (torque) is recommended.) And it is recommended to apply fire resistance paint onto the cable between ACU and Expansion Battery cable glands.

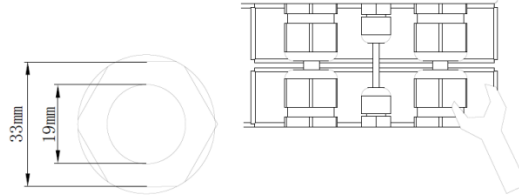

Step 7: screwing up the plates, then screw up the cover plates back to the inverter and battery respectively (14kgf.cm (torque) is recommended.)

Step 8: Screw the grounding cable into the grounding port of inverter enclosure and battery enclosure. If there are more than one battery, screw the grounding cable into the grounding ports of two battery enclosures.

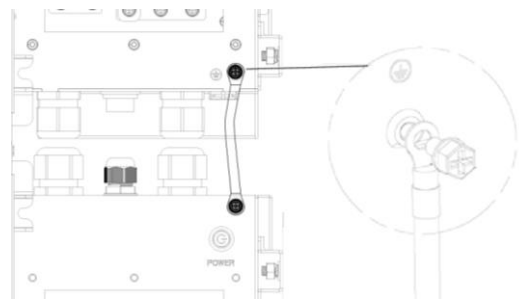

5.6 DRM Port Description

To comply with Australian and New Zealand safety requirements, the DRMs terminals should be connected. A RJ45 plug is being used as the inverter DRED connection.

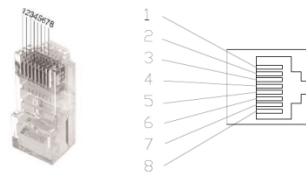

Object	Corresponding Pins	Requirement
DRM0	5 & 6	The inverter is on standby mode
DRM1	1 & 6	The inverter is not consuming power
DRM2	2 & 6	The inverter is consuming less than 50% of rated power
DRM3	3 & 6	The inverter is consuming less than 75% of rated power AND source reactive power if capable
DRM4	4 & 6	The inverter is consuming 100% of rated power (Subject to constrains from other active DRMs)
DRM5	1 & 5	The inverter is not generating power
DRM6	2 & 5	The inverter is generating less than 50% of the rated power
DRM7	3 & 5	The inverter is generating less than 75% of the rated power AND sink reactive power if capable
DRM8	4 & 5	The inverter is generating 100% of rated power (Subject to constrains from other active DRMs)

5.7 CT Installation

CT solution is offered for sampling data of grid side as standard solution.

Please install CT with instructions as below:

- 1) Lead the Live line through the CT.
- 2) Tighten up the CT buckles.
- 3) Remove the cover of CT port on the right side of inverter.
- 4) Connect RJ45 plug of the CT to the CT port.

Note!



- CT direction shall point to the grid side. Please notice the CT direction.
- The CT should be installed near the grid.

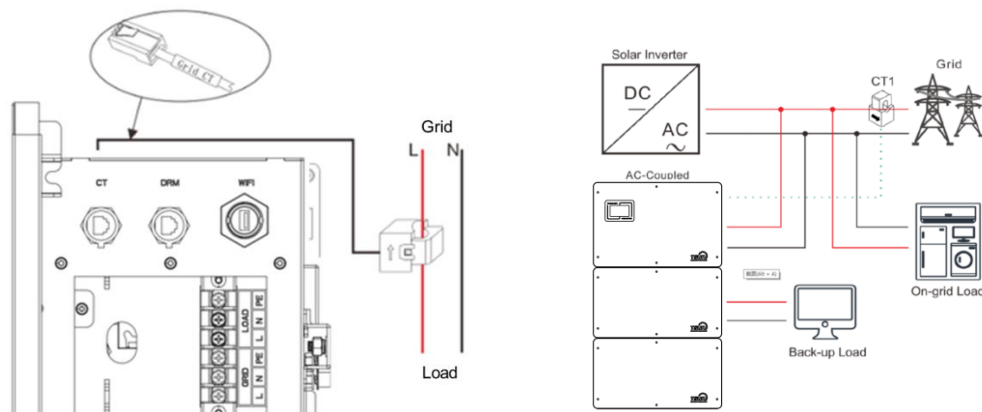

5.8 External AC Circuit Breaker and Residual Current Device

Please install a circuit breaker to ensure the inverter is able to disconnect from grid safely. The inverter is integrated with a RCMU; however, an external RCD is needed to protect the system from tripping, either type A or type B RCD are compatible with the inverter.

The integrated leakage current detector of inverter is able to detect the real time external current leakage. When a leakage current detected exceeds the limitation, the inverter will be disconnected from grid quickly, if an external residual current device is connected, the action current should be 30mA or higher.

6 Local Configuration

6.1 Local Interface Introduction

TSUN Storage Unit has a touch screen on the front of inverter.

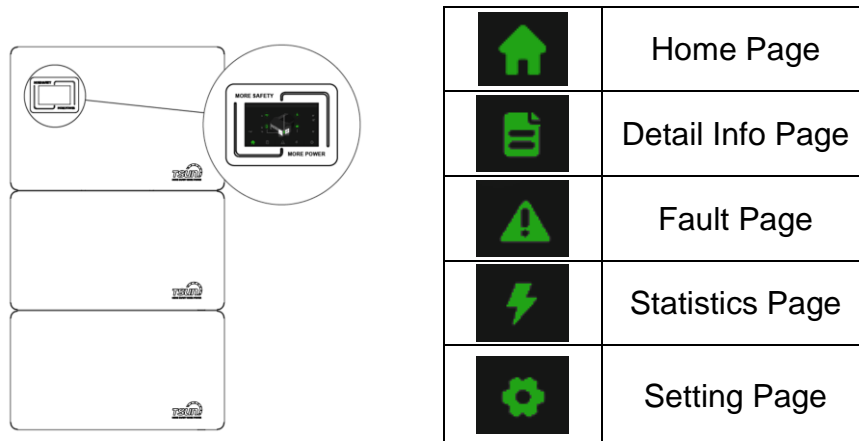

6.2 Home Page

This page shows the total PV input power, AC grid power, battery power and SOC, load power.



6.3 Detail Info Page

6.3.1 PV Info Page (only Hybrid)

This page shows the voltage, current and power of two different PV inputs.

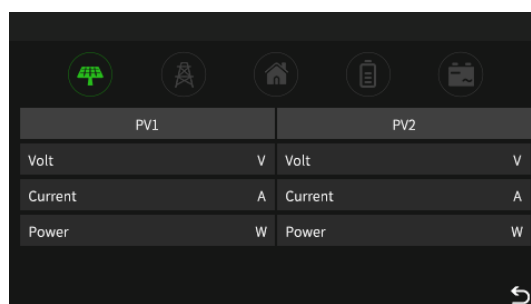

6.3.2 Grid Info Page

This page shows the voltage, current, power and frequency of AC grid.

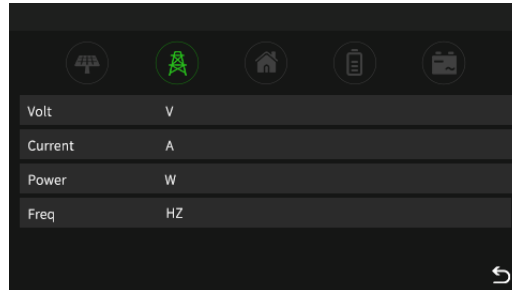

6.3.3 Load Info Page

This page shows the voltage, current and power of the loads.

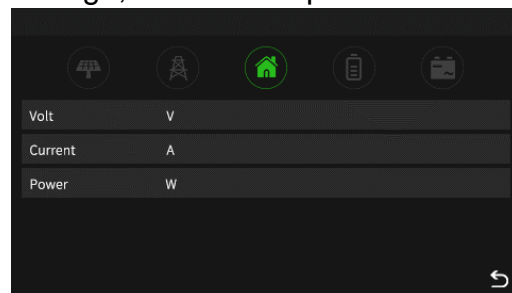

6.3.4 Battery Info Page

This page shows the voltage, SOC, temperature, current, power and charging/discharging limit of the battery.

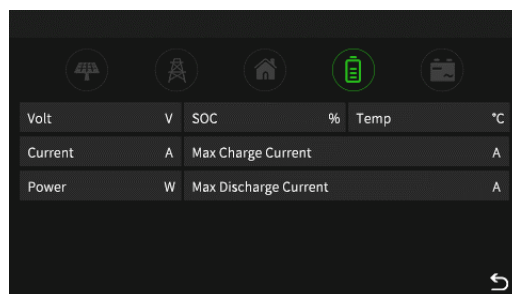

6.3.5 Inverter Info Page

This page shows the BUS voltage, internal temperature of the inverter.

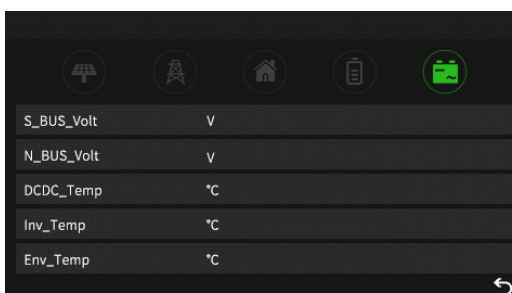

6.4 Fault Page

This page shows the real-time fault alarm and fault history of the storage unit.

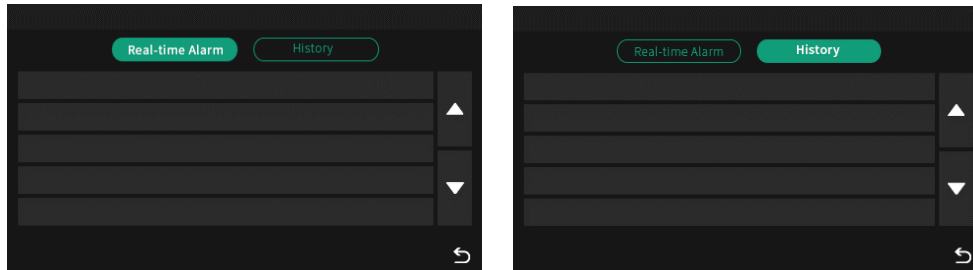

6.5 Statistics Page

These two pages show statistics info of Grid, Battery, PV and Load.

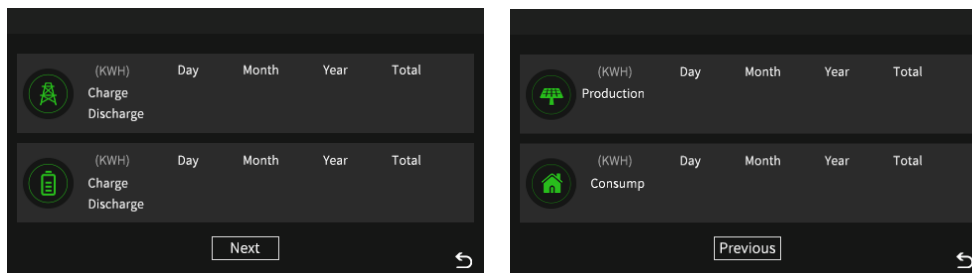

6.6 Setting Page

6.6.1 Brightness Setting Page

This page shows the brightness setting and screen off time setting.

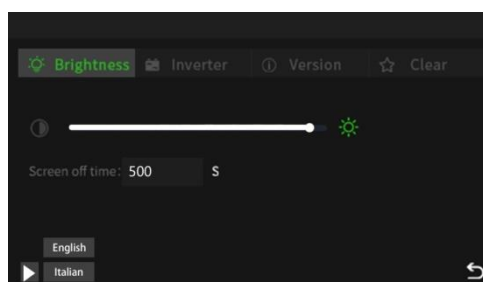

The value range is shown as below:

Item	Description	Range
Brightness	the brightness of screen	Min - Max
Screen off time	the time to turn off the screen	5 – 500 s

6.6.2 Inverter Setting Page

This page needs a password. The default password is “12345”. Installer can change it in this menu.

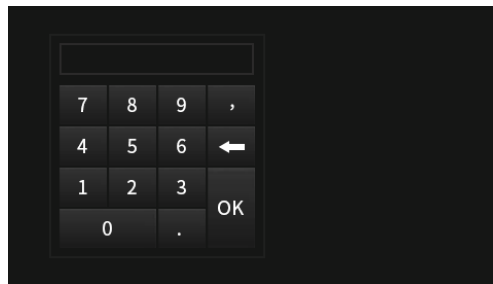

1) System Setting

This page shows the work mode setting, PV input setting, EPS Enable setting, battery awaken setting, zero export setting, Arc detection setting, date setting and time setting.

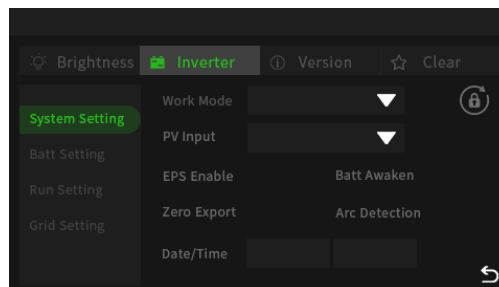

The value range is shown as below:

Item	Description	Default Setting	Range
Work Mode	Work mode of the storage unit	Self Consume	① Self Consume ② Peak Shift ③ Bat Priority
PV Input	PV input mode of the storage unit	Independent	① Independent ② Parallel ③ CV (only factory test)
EPS Enable	Turn on/off the EPS output	OFF	ON / OFF
Batt Awaken	Wake up the battery in some special time	OFF	ON / OFF
Zero Export	Limit the export power to the public power grid	OFF	ON / OFF
Arc Detection	Turn on/off the Arc detection of PV	OFF	ON / OFF
Date	Date	-	20000101 – 20991231
Time	Time	-	000000 – 235959
Password	Reset the password	12345	10000 - 65535

Note!



- The “CV” mode in the PV Input setting is used for the factory test. Don't choose it during the installation.
- The “Date” should be set with 8 numbers. First 4 numbers are “year”. Second 2 numbers are “Month”. Last 2 numbers are “Day”. “20000101” means January 1st, 2000.
- The “Time” should be set with 6 numbers. First 2 numbers are “hour”. Second 2 numbers are “minute”. Last 2 numbers are “second”. “120101” means 12:01:01.

Self Consume Mode:

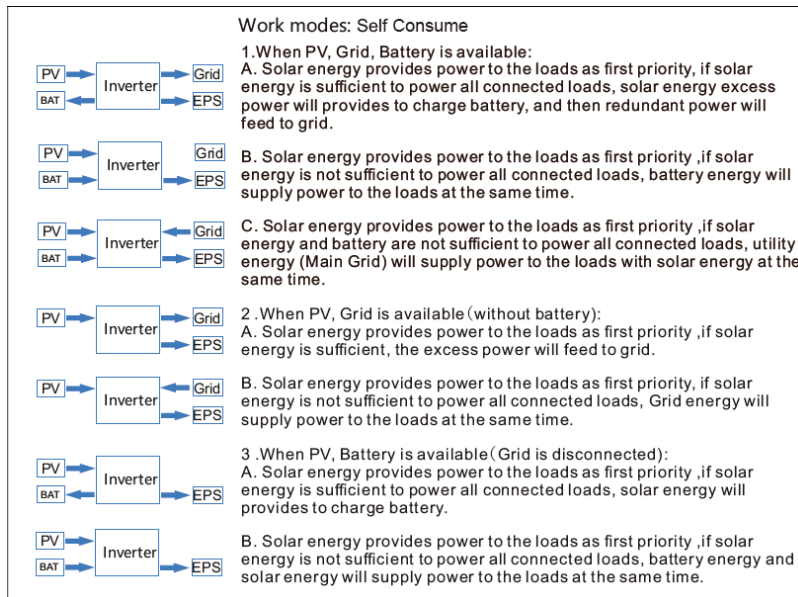

Peak Shift Mode:

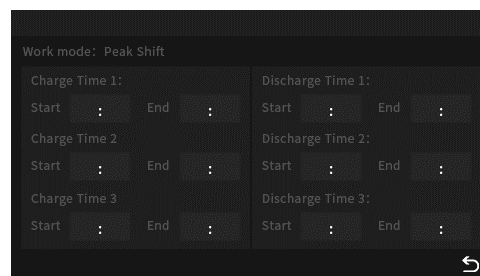
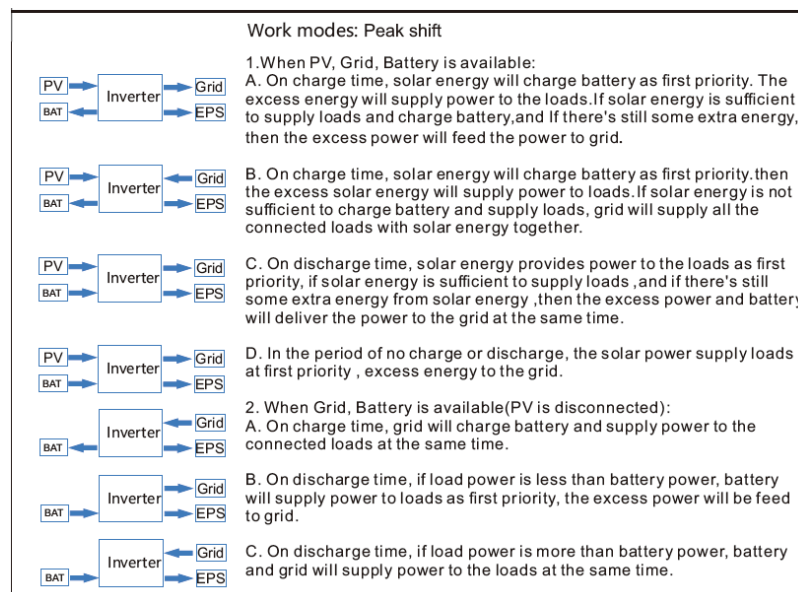

Item	Description	Range
Start	Start time of charge/discharge	0000 – 2359
End	End time of charge/discharge	0000 – 2359

Note!



- The “Start” and “End” should be set with 4 numbers. First 2 numbers are “hour”. Second 2 numbers are “minute”. For example: “1201” means 12:01
- The start time and end time in this page should not be the same, except 00:00.
- Every charge time and discharge time should not cover each other. For example: if charge time is set 8:00 to 9:00 and discharge time is set 8:30 to 9:30, the inverter will not work.

Bat Priority Mode:

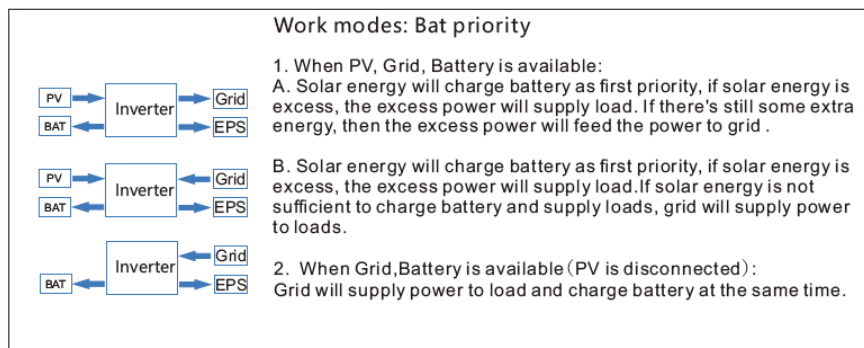

2) Batt Setting

This page shows the battery type setting, on-grid DOD setting, off-grid DOD setting, charge current setting, Hysteresis setting, battery communication setting and grid rate setting.

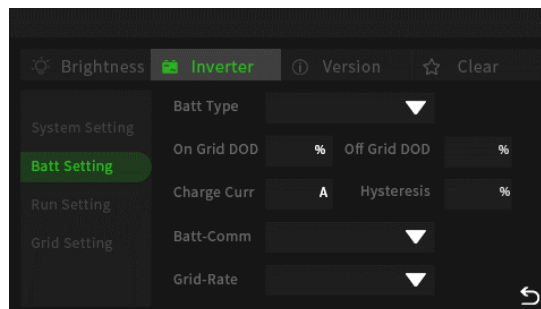

The value range is shown as below:

Item	Description	Default Setting	Range
Batt Type	Battery type of the storage unit	Lithium	① DC Source (only factory test) ② Lead-Acid (only service test) ③ Lithium
On-grid DOD	Depth of discharge in the on-grid mode	80	10 - 90

Off-grid DOD	Depth of discharge in the off-grid mode	80	10 - 90
Charge-Curr	Current limit of charge	100	1 - 170
Hysteresis	Hysteresis of the battery DoD	20	10 - 90
Batt-Comm	Battery communication type of the storage unit	CAN	① RS485 ② CAN
Grid-Rate	type of the AC power grid	220V Single	① 220 V Single ② 120V/240V ③ 120V/208V ④ 120V Single

Note!



- The “Batt Type” should be set as “Lithium”. Don’t choose others during the installation.
- The “Batt Comm” should be set as “CAN”. Don’t choose others during the installation.

3) Runing Setting

This page shows the react mode setting, grid power setting, discharge power setting, grid voltage setting, grid frequency setting and grid standard setting.

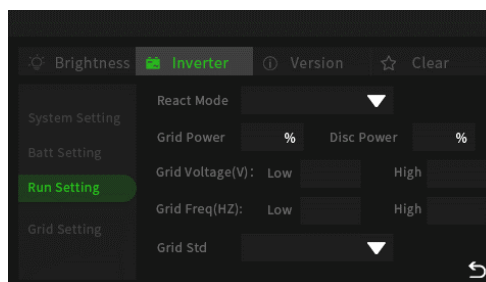

The value range is shown as below:

Item	Description	Default Setting	Range
React Mode	The react mode of the storage unit	Power Factor	① Power Factor ② React Power ③ Qu Wave ④ Qp Wave
Grid Power	export power to the AC power grid	100	0 - 100
Disc Power	Discharge power of the battery	100	0 - 100
Grid Voltage (Low)	Change the protection setting if it is different from the grid standard	176.0	150.0 – 220.0
Grid Voltage (High)		270.0	240.0 – 280.0
Grid Frequency (Low)		42.00	40.00 – 70.00
Grid Frequency (High)		58.00	40.00 – 70.00
Grid Std	grid standard for different counties	CN	Shown as below

Note!



- The Grid Standard is shown as below and it will keep updating with the certificate testing.

AU	US	ITA
AU-W	THAIL	SLO
NZ	ZA	CZE
UK	custom	SWE
PK	POL	HU
KR	EN50549	SK
PHI	VDE4105	AT
CN	JPN	BE

4) About "Autotest"

According to the requirements of the Italian grid standard CEI0-21, inverter needs to have IPS self-inspection function. In the interface for selecting grid standards, click ITA to enter the Autotest interface.

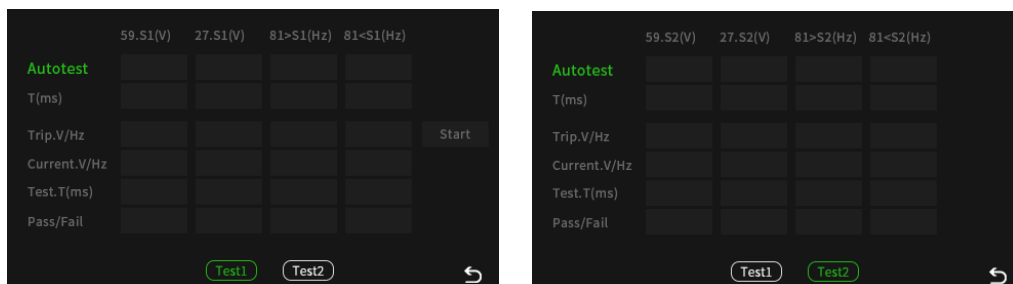

Click "Start" to enter the test interface below. Note that the test can only begin when the power grid is connected.

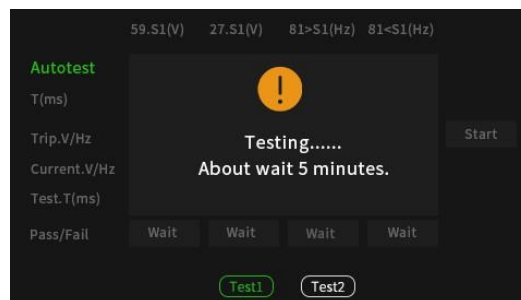

After waiting for 5 minutes, the following interface is displayed

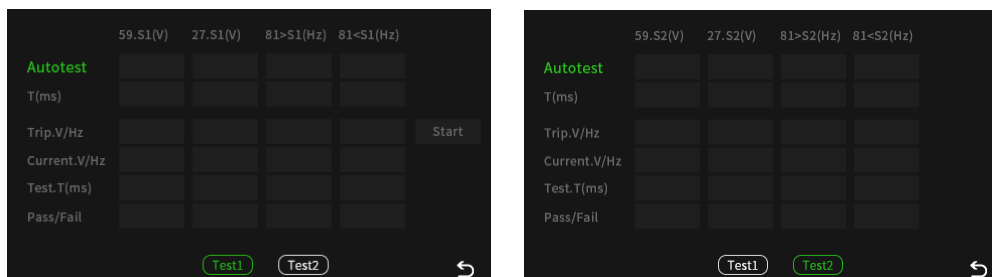

Test1, Test2, the interface shows the PASS data represents the test passed.

5) Grid Setting

This page shows the voltage reset setting, frequency reset setting, leak current setting, active island setting and insulation detection setting.

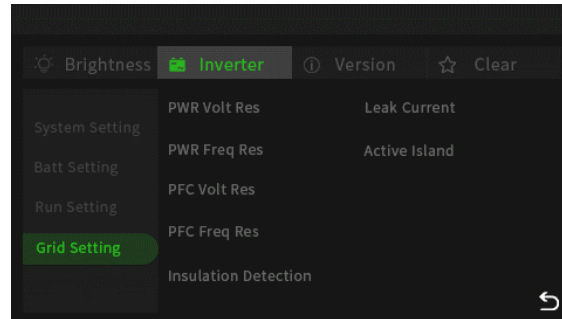

Item	Description	Default Setting	Range
PWR-Volt Res	Turn on/off the protect setting	ON	ON / OFF
PWR-Freq Res		ON	ON / OFF
PFC-Volt Res		ON	ON / OFF
PFC-Freq Res		ON	ON / OFF
Leak Current		ON	ON / OFF
Active Island		ON	ON / OFF
Insulation Detection		ON	ON / OFF

6.6.3 Version Page

This page shows the version and serial number of the storage unit.

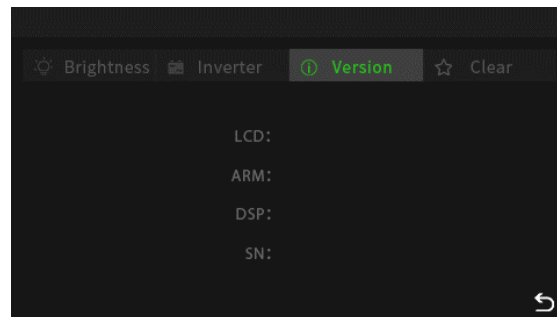

6.6.4 Clear Page

This page needs a password. The default password is "12345". Installer can change it in the inverter setting.

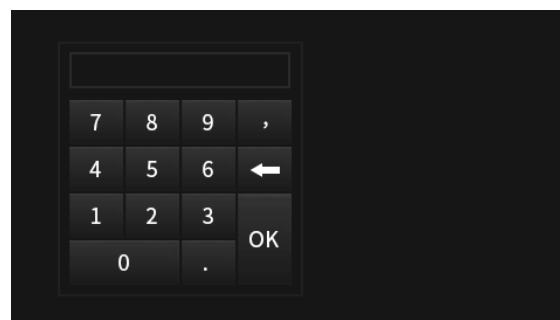

This page shows the clear options of the storage.

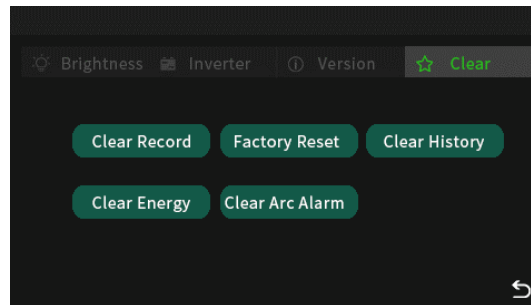

Note!

- All the data can not be restored after the clearance!

6.7 Start up the System

The system shall be turned ON in the correct sequence as follows:

- 1) Turn ON the BAT switch at the right side of the inverter.
- 2) Press power button at the right side of the batteries to turn on batteries, the order should be Battery No.4> Battery No.3> Battery No.2> Battery No.1;
- 3) Wait for 30s and observe the LCD on the front of inverter to check the running status.
- 4) Turn ON the PV switch at the left side of the inverter (only Hybrid).
- 5) Turn on external AC switch.
- 6) If the system is running normal, please do commission configuration. If the system is not work normally, please re-check the wiring and setting until the system runs normal.
- 7) Set the details on the local screen.



Note!

- The start-up procedure for the system should be: Inverter BAT switch >> Battery No. 4>> Battery No. 3>> Battery No.2>> Battery No.1 >>Inverter PV switch (only Hybrid) >> External AC switch.

6.8 Shut Down the System

System shall be turned OFF in the correct sequence as follows:

- 1) Turn off the external grid AC switch.
- 2) Turn off the PV switch at the left side of the inverter (only Hybrid).
- 3) Press the POWER button on the right side of the battery. the order should be Battery No.4> Battery No.3> Battery No.2> Battery No.1;
- 4) Turn OFF the Battery switch on the right side of the inverter.



Note!

- The procedure for turning off the system will be External AC switch >> Inverter PV switch (only Hybrid) >> Battery No.4>> Battery No.3>> Battery No.2>> Battery No.1>> Inverter BAT switch.

7 Monitoring Configuration

7.1 Download the APP

Download “TSUN Smart” App in Apple Store or Google Play.



7.2 Register an Account

Click “Register” and choose an account type. Fill in all the information and finish the registration.

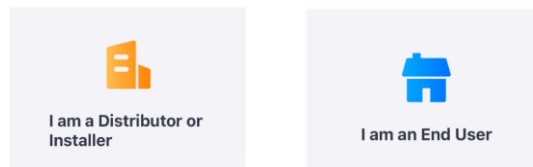

Item	Distributor	Installer	End User
TSUN Smart APP	✓	✓	✓
TSUN Portal Web	✓	✓	
Create Solar Plant	✓	✓	✓
Add Device	✓	✓	✓
Wi-Fi Configuration	✓	✓	✓
Remote Update	✓	✓	
Device Management	✓		

7.3 Create a Solar Plant (Installer)

Click “ + ” and create a Solar Plant. Fill in the plant information and click “Save”.

Cancel
Create Plant
Save

Cover 

*Plant Name Storage Demo

*Location Longitude120°40'35.1" >
Latitude31°28'29.2" >

*Region China Jiangsu Suzhou >
Xiangchengqu >



Note!

- The “System Type” must be set to “Solar + Storage + Consumption + Grid”.

7.4 Add a Device (Installer)

Click “Add Datalogger” when the solar plant is created.

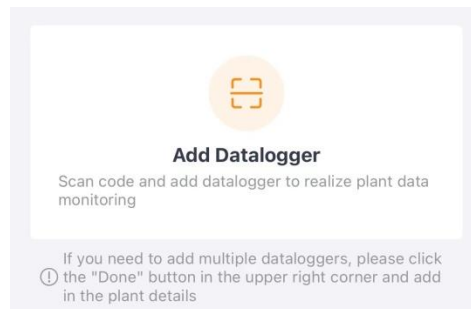

Scan the QR code in the data logger and add this device.

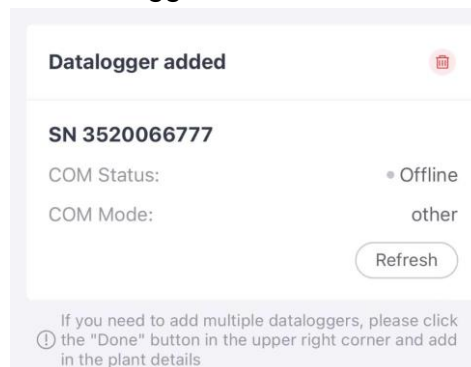

7.5 Authorize to End User (Installer)

Click “Authorize plants to End User”.

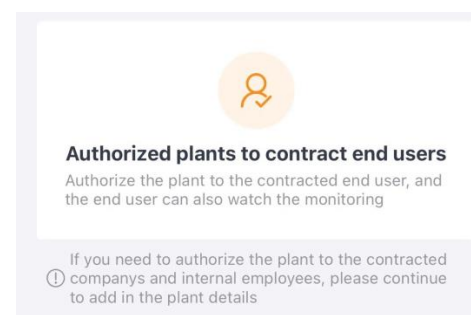

Create the account for end user or select an existed end user account.

Contract Recipient:

*Name Storage User

*E-mail sun-

*Password sun-

Does the end user have an account? [Click here](#) to search for the account

7.6 Wi-Fi Configuration (Installer)

Assemble data logger to the WiFi port of storage unit.

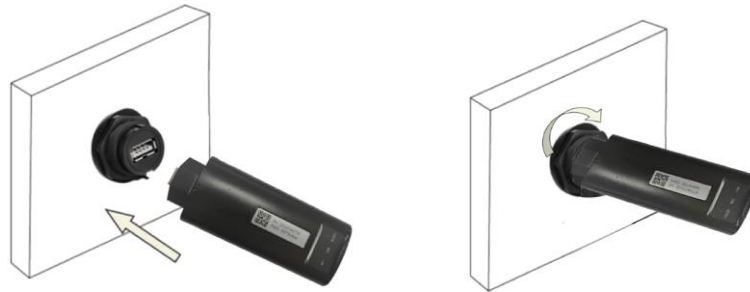





Click “WiFi Configuration” in “ME” Page.



WiFi Configuration

Click “+Add” and scan the QR code in the data logger. Choose the device and click “Next”.

Select the device to config the WiFi network

1. Devices can't connect to 5G network. Please change to 2.4G network!
2. Devices in gray can't do the multi-configuration.
3.    Indicating three different types of gateways, it does not support networking at the same time, you need to select one or more devices of the same type before networking.
4.  The type of gateway does not support bulk networking, it supports one device at a time.
5. Swipe left to delete the device.

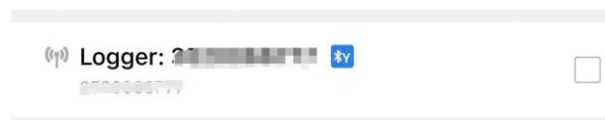

Choose a WiFi Network and fill in the password.

Enter WiFi password

This device can't connect to 5G network. Please change to 2.4G network!

TSUN-TEST1 Change

Need a password?

👁️

Click “Start Config” and this configuration will be finished in 30s.

< Device Configuration

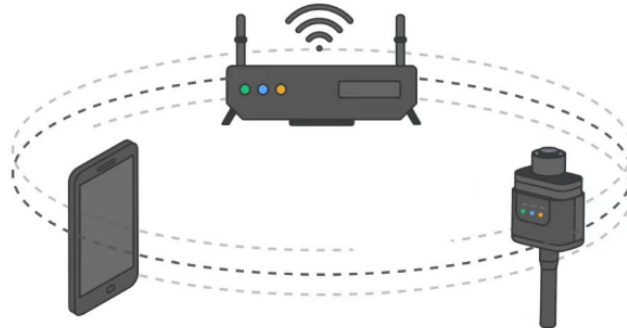

Please keep your phone close to the device.

Logger 

 Configuring

Plant data and device data will be updated in 10 minutes.

7.7 Login TSUN Smart and Monitor the Solar Plant (End User)

Use End User account to login TSUN Smart. Plant information will be shown in the App.

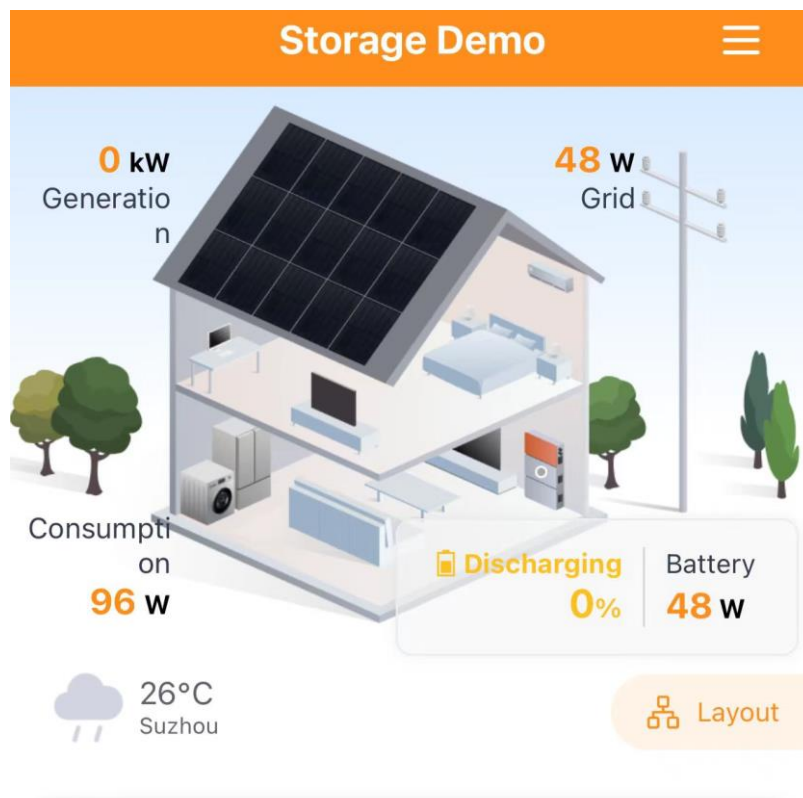

8 Fault Codes and Common Troubleshooting

Content	Codes	Explanation	Solution
Over Discharge Current	001	1, If work in the off-grid mode, the load is higher than inverter power. 2, The discharge current limit is too low. 3, If install only one battery, the inverter power is higher than 5kW.	1, If work in the off-grid mode, check the off-grid load and make sure it is lower than the inverter output power. 2, Check the discharge current limit and set a higher value. 3, If install only one battery, try to install more batteries. 4, If the problem still exists, contact TSUN.
Over Load	002	If work in the off-grid mode, the load is too high.	1, If work in the off-grid mode, check the off-grid load and make sure it is lower than the inverter output power and battery power. 2, If the load is inductive load, wait for several minutes and check if the problem still exists. 3, If the problem still exists, contact TSUN.
Batt. Disconnected	003	1, Battery switch is turned off. 2, Battery button is turned off. 3, Battery cables are disconnected. 4, Battery fuse is disconnected.	1, Check the battery switch and turn it on. 2, Check the battery button and turn it on. 3, Check the battery cables. 4, Check the battery fuse. 5, If the problem still exists, contact TSUN.
Batt. Under Capacity	004	Battery capacity is low and the battery voltage is low.	1, Charge the battery and keep the capacity higher than 20%. 2, If the problem still exists, contact TSUN.
Batt. Low Capacity	005	Battery capacity is low.	1, Charge the battery and keep the capacity higher than (SOC>100%-DOD+Hysteresis). 2, If the problem still exists, contact TSUN.
batt. High Volt	006	1, Battery is damaged. 2, Battery sampling is damaged.	1, Measure the voltage and check if it is normal. 2, If the problem still exists, contact TSUN.
Grid Low Volt	007	Grid voltage is abnormal.	1, Check if the power grid is normal. 2, Check if the country is set correctly 3, Check if the voltage range is set correctly 4, If the problem still exists, contact TSUN.
Grid High Volt	008		
Grid Low Freq.	009	Grid Frequency is abnormal.	1, Check if the power grid is normal. 2, Check if the country is set correctly 3, Check if the frequency range is set correctly 4, If the problem still exists, contact TSUN.
Grid High Freq.	010		
BUS Low Volt	014	BUS voltage is lower than normal.	Restart the system. If the problem still exists, contact TSUN.
BUS High Volt	015	BUS voltage is over maximum value.	1, Check if the PV input voltage is higher than limit. 2, Check if the battery is too high 3, Restart the system. If the problem still exists, contact TSUN.
Inv. Over Current	016	1, If work in the off-grid mode, the load is too high. 2, If work in the off-grid mode, the RCD load is too high. (For example, air-conditioning)	1, Check the load and make sure it is lower than the inverter output power. 2, Restart the system. If the problem still exists, contact TSUN.
Over Charge Current	017	1, The battery charge limit is too high. 2, If install only one battery, the inverter charge power is higher than 5kW.	1, Check if the inverter charge limit is set correctly. 2, If install only one battery, try to install more batteries. 3, If the problem still exists, contact TSUN.
Inv. Under Volt	019	INV voltage is abnormal.	If the problem still exists, contact TSUN.
Inv. Over Volt	020		

Inv. Abnormality Freq.	021	INV frequency is abnormal.	If the problem still exists, contact TSUN.
IGBT High Temp.	022	Bad heat dissipation of inverter.	1, Check the installation position and keep a good heat dissipation of inverter. 2, If the problem still exists, contact TSUN.
Batt. Over Temp.	024	1, Bad heat dissipation of battery. 2, Battery keeps discharge within a high power.	1, Check the installation position and keep a good heat dissipation of battery. 2, If in the Peak Shift mode, change a shorter discharge time. 3, If in the Self Consume mode, install more batteries. 4, If the problem still exists, contact TSUN.
Batt. Under Temp.	025	Battery temperature is lower than the allowed value.	1, Check if the environment temperature is too low. 2, Use small load first until the warning disappear. 3, If the problem still exists, contact TSUN.
BMS Comm. Fail	028	1, Battery communication cable is damaged, 2, Battery address is set incorrectly. 3, Battery button is turned off.	1, Check if the battery button is turned on. 2, Check if the battery communication cable is normal. 3, Check if the battery address is set correctly. 4, If the problem still exists, contact TSUN.
Fan Fail	029	Fan fail.	1, If the problem still exists, contact TSUN.
Grid Over Load	030	The bypass load in the grid side is too high.	1, Check if the off-grid load is too high. 2, If the problem still exists, contact TSUN.
BUS Soft Start Fail	033	The inverter may be damaged.	1, Restart the system. If the problem still exists, contact TSUN.
Inv. Soft Start Fail	034		
BUS Short Circuit	035		
Inv. Short Circuit	036		
Fan Locked Fail	037	Fan fault.	1, If the problem still exists, contact TSUN.
PV Insulation Low	038	PV Low insulation impedance.	1, Check if the PV cable is damaged. 2, When it is raining, keep observing and check if the problem still exists when it is sunny. 3, If the problem still exists when it is sunny, contact TSUN.
BUS Relay Fault	039	The inverter may be damaged.	1, Restart the system. If the problem still exists, contact TSUN.
Grid Relay Fault	040		
EPS Relay Fault	041		
GFCI Fault	042		
PV Input Short Circuit	044		
Bypass Relay Fault	045		
System Fault	046		
Inv. Current DC Over	047		
Inv. Volt DC Over	048		

9 Battery Maintenance

9.1 Transportation

Lithium batteries are dangerous goods. Passed the test of UN38.3, this product meets the transportation requirements for dangerous goods for lithium batteries. After the installation of the battery on site, the original packaging (contains the lithium battery identification) should be kept. When the battery needs to be returned to the factory for repair, please pack the battery with the original packaging to reduce unnecessary trouble.

9.2 Storage

9.2.1 Lithium Battery Storage

After purchasing the battery, please store it with following instructions:

- 1) Please store it in a dry and ventilated environment, keep it away from heat sources.
- 2) Please keep it in an environment with storage temperature as $-20^{\circ}\text{C} \sim 50^{\circ}\text{C}$, humidity $<85\% \text{ RH}$.
- 3) For long-term storage (>3 months), please put it in an environment with a temperature of 18°C to 28°C and a humidity of $< 85\% \text{ RH}$.
- 4) The battery should be stored in accordance with the storage requirements mentioned above, and the battery should be installed within 6 months since delivered from the factory and used with compatible inverters.



Note !

- The battery remains 40% power when it is sent from the factory.
- The longer the battery is stored, the DOD value is getting bigger. When the battery remaining voltage fails to reach the startup voltage requirement, the battery may be damaged.

The battery cannot be disposed of as household refuse. When the service life of the battery reaches to the limit, it is not required to return it to the dealer or TSUNESS, but it must be recycled to the special waste lithium battery recycling station in the area.

9.2.2 Inverter Storage

- ① Do not dispose of the original packing case. It is recommended to store the device in the original packing case when the device is decommissioned.
- ② The storage temperature and humidity should be in the range of -30°C and $+60^{\circ}\text{C}$, and less than 90%, respectively.
- ③ If a batch of inverters needs to be stored, the height of each pile should be no more than 6 levels.

9.3 Cleanliness

Clean the enclosure lid, LCD of the inverter with moistened cloth with clear water only. Do not use any cleaning agents as it may damage the components.



TSUNESS Co., Ltd

 www.tsun-ess.com

 sales@tsun-ess.com

 No. 55 Aigehao Road, Weitang Town, Xiangcheng District,
Suzhou City, jiangsu Province, P.R.China